

**DSA8200**  
**Digital Serial Analyzer**  
**Quick Start User Manual**





**DSA8200**  
**Digital Serial Analyzer**  
**Quick Start User Manual**

Copyright © Tektronix. All rights reserved. Licensed software products are owned by Tektronix or its subsidiaries or suppliers, and are protected by national copyright laws and international treaty provisions.

Tektronix products are covered by U.S. and foreign patents, issued and pending. Information in this publication supersedes that in all previously published material. Specifications and price change privileges reserved.

TEKTRONIX and TEK are registered trademarks of Tektronix, Inc.

TEKPROBE and FrameScan are registered trademarks of Tektronix, Inc.

## **Contacting Tektronix**

Tektronix, Inc.  
14200 SW Karl Braun Drive  
P.O. Box 500  
Beaverton, OR 97077  
USA

For product information, sales, service, and technical support:

- In North America, call 1-800-833-9200.
- Worldwide, visit [www.tektronix.com](http://www.tektronix.com) to find contacts in your area.

## Warranty

Tektronix warrants that this product will be free from defects in materials and workmanship for a period of one (1) year from the date of shipment. If any such product proves defective during this warranty period, Tektronix, at its option, either will repair the defective product without charge for parts and labor, or will provide a replacement in exchange for the defective product. Parts, modules and replacement products used by Tektronix for warranty work may be new or reconditioned to like new performance. All replaced parts, modules and products become the property of Tektronix.

In order to obtain service under this warranty, Customer must notify Tektronix of the defect before the expiration of the warranty period and make suitable arrangements for the performance of service. Customer shall be responsible for packaging and shipping the defective product to the service center designated by Tektronix, with shipping charges prepaid. Tektronix shall pay for the return of the product to Customer if the shipment is to a location within the country in which the Tektronix service center is located. Customer shall be responsible for paying all shipping charges, duties, taxes, and any other charges for products returned to any other locations.

This warranty shall not apply to any defect, failure or damage caused by improper use or improper or inadequate maintenance and care. Tektronix shall not be obligated to furnish service under this warranty a) to repair damage resulting from attempts by personnel other than Tektronix representatives to install, repair or service the product; b) to repair damage resulting from improper use or connection to incompatible equipment; c) to repair any damage or malfunction caused by the use of non-Tektronix supplies; or d) to service a product that has been modified or integrated with other products when the effect of such modification or integration increases the time or difficulty of servicing the product.

THIS WARRANTY IS GIVEN BY TEKTRONIX WITH RESPECT TO THE PRODUCT IN LIEU OF ANY OTHER WARRANTIES, EXPRESS OR IMPLIED. TEKTRONIX AND ITS VENDORS DISCLAIM ANY IMPLIED WARRANTIES OF MERCHANTABILITY OR FITNESS FOR A PARTICULAR PURPOSE. TEKTRONIX' RESPONSIBILITY TO REPAIR OR REPLACE DEFECTIVE PRODUCTS IS THE SOLE AND EXCLUSIVE REMEDY PROVIDED TO THE CUSTOMER FOR BREACH OF THIS WARRANTY. TEKTRONIX AND ITS VENDORS WILL NOT BE LIABLE FOR ANY INDIRECT, SPECIAL, INCIDENTAL, OR CONSEQUENTIAL DAMAGES IRRESPECTIVE OF WHETHER TEKTRONIX OR THE VENDOR HAS ADVANCE NOTICE OF THE POSSIBILITY OF SUCH DAMAGES.

[W2 – 15AUG04]



# Table of Contents

General Safety Summary .....	iii
Compliance Information .....	v
EMC Compliance.....	v
Safety Compliance .....	vii
Environmental Considerations.....	ix
Preface .....	x
Documentation .....	x
Conventions Used in this Manual .....	xi
Key Features.....	1
Install Your Instrument.....	3
Standard Accessories.....	3
Operating Considerations.....	4
Installing Modules .....	6
Powering the Instrument On and Off .....	7
Adding a Second Monitor .....	8
Changing the Windows Language .....	10
Getting Acquainted with Your Instrument.....	13
Front Panel .....	13
Control Panel .....	14
Rear Panel .....	16
Computer I/O Panel .....	17
Interface .....	17
Display - Single Graticule View.....	19
Display - Multiple Views.....	20
Accessing Online Help.....	20
Inspect Your Instrument .....	23
Verify Internal Diagnostics Pass.....	23
Optimizing Measurement Accuracy.....	25
Signal Path Compensation .....	25
Perform Dark-Level and User Wavelength Gain Compensations.....	27
Acquisition .....	30
Setting Up Signal Input .....	30
Using Autoset .....	32
Using Default Setup.....	32
Accessing the Setup Dialog Boxes.....	33
Changing the Acquisition Mode .....	34
Setting the Display Style.....	35
Triggers .....	37
Triggering Concepts.....	37
Setting Trigger Controls.....	40
Setting Pattern Sync Controls .....	41
Checking Trigger Status .....	42

Analyzing Waveforms .....	43
Taking Automatic Measurements.....	43
Turning Off Automatic Measurements.....	47
Cursor Measurements .....	48
Math Waveforms .....	50
Waveform Databases .....	52
Display a Communication Signal .....	53
Display and Analyze Communication Signals Using Mask Testing .....	54
FrameScan .....	57
To Use TDR .....	58
Phase Reference.....	60
Histograms .....	61
Document Your Results.....	63
Using the 80A05 Electrical Clock Recovery Module Examples .....	65
Clock Recovery / Trigger on Recovered Clock .....	66
Clock Recovery / Trigger for Optical Signal, with the 80C12 Optical Module .....	67
Differential Clock Recovery and Acquisition .....	68
Probing with Low-Impedance Probes .....	69
Probing with Differential to Single-Ended Probes.....	70
Vertical Gain Adjustment.....	71
Skew and Deskewing.....	72
Methods to Adjust Skew .....	72
Setup Considerations and Procedures.....	73
Acquisition Deskew Procedure .....	78
TDR Step Deskew Procedure .....	81
Cleaning the Instrument.....	85
Exterior Cleaning.....	85
Flat Panel Display Cleaning .....	85
Optical Connector Cleaning .....	85
Restoring the Operating System.....	86
Restoring the Operating System with Restore Discs .....	87
Restoring the Operating System from the Instrument Hard Disk Drive (SN B020551 through B029999) .....	87
Create Restore CD-ROMs (Serial Numbers B020551 to B029999) .....	88
Index	



# General Safety Summary

Review the following safety precautions to avoid injury and prevent damage to this product or any products connected to it.

To avoid potential hazards, use this product only as specified.

*Only qualified personnel should perform service procedures.*

While using this product, you may need to access other parts of a larger system. Read the safety sections of the other component manuals for warnings and cautions related to operating the system.

## To Avoid Fire or Personal Injury

**Use Proper Power Cord.** Use only the power cord specified for this product and certified for the country of use.

**Connect and Disconnect Properly.** Do not connect or disconnect probes or test leads while they are connected to a voltage source.

**Ground the Product.** This product is grounded through the grounding conductor of the power cord. To avoid electric shock, the grounding conductor must be connected to earth ground. Before making connections to the input or output terminals of the product, ensure that the product is properly grounded.

**Observe All Terminal Ratings.** To avoid fire or shock hazard, observe all ratings and markings on the product. Consult the product manual for further ratings information before making connections to the product.

The inputs are not rated for connection to mains or Category II, III, or IV circuits.

Do not apply a potential to any terminal, including the common terminal, that exceeds the maximum rating of that terminal.

**Power Disconnect.** The power switch disconnects the product from the power source. See instructions for the location. Do not block the power switch; it must remain accessible to the user at all times.

**Do Not Operate Without Covers.** Do not operate this product with covers or panels removed.

**Do Not Operate With Suspected Failures.** If you suspect that there is damage to this product, have it inspected by qualified service personnel.

**Avoid Exposed Circuitry.** Do not touch exposed connections and components when power is present.

**Use Proper Fuse.** Use only the fuse type and rating specified for this product.

**Wear Eye Protection.** Wear eye protection if exposure to high-intensity rays or laser radiation exists.

**Do Not Operate in Wet/Damp Conditions.**

**Do Not Operate in an Explosive Atmosphere.**

**Keep Product Surfaces Clean and Dry.**

**Provide Proper Ventilation.** Refer to the manual's installation instructions for details on installing the product so it has proper ventilation.

## Terms in this Manual

These terms may appear in this manual:



---

**WARNING.** *Warning statements identify conditions or practices that could result in injury or loss of life.*

---



---

**CAUTION.** *Caution statements identify conditions or practices that could result in damage to this product or other property.*

---

## Symbols and Terms on the Product

These terms may appear on the product:

- DANGER indicates an injury hazard immediately accessible as you read the marking.
- WARNING indicates an injury hazard not immediately accessible as you read the marking.
- CAUTION indicates a hazard to property including the product.

The following symbol(s) may appear on the product:

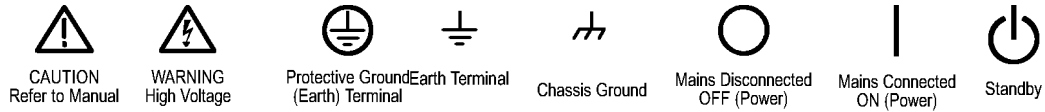

# Compliance Information

This section lists the EMC (electromagnetic compliance), safety, and environmental standards with which the instrument complies.

## EMC Compliance

### EC Declaration of Conformity – EMC

Meets intent of Directive 2004/108/EC for Electromagnetic Compatibility. Compliance was demonstrated to the following specifications as listed in the Official Journal of the European Communities:

**EN 61326-1:2006, EN 61326-2-1:2006.** EMC requirements for electrical equipment for measurement, control, and laboratory use.<sup>1 2 3 6</sup>

- CISPR 11:2003. Radiated and conducted emissions, Group 1, Class A
- IEC 61000-4-2:2001. Electrostatic discharge immunity
- IEC 61000-4-3:2002. RF electromagnetic field immunity<sup>4</sup>
- IEC 61000-4-4:2004. Electrical fast transient / burst immunity
- IEC 61000-4-5:2001. Power line surge immunity
- IEC 61000-4-6:2003. Conducted RF immunity
- IEC 61000-4-11:2004. Voltage dips and interruptions immunity<sup>5</sup>

**EN 61000-3-2:2006.** AC power line harmonic emissions

**EN 61000-3-3:1995.** Voltage changes, fluctuations, and flicker

### European Contact.

Tektronix UK, Ltd.  
Western Peninsula  
Western Road  
Bracknell, RG12 1RF  
United Kingdom

- <sup>1</sup> This product is intended for use in nonresidential areas only. Use in residential areas may cause electromagnetic interference.
- <sup>2</sup> Emissions which exceed the levels required by this standard may occur when this equipment is connected to a test object.
- <sup>3</sup> To ensure compliance with the EMC standards listed here, high quality shielded interface cables should be used.
- <sup>4</sup> Horizontal timing susceptibility of the optical sampling modules and their internal clock recovery trigger signals usually increases the horizontal timing jitter when external electromagnetic fields are applied. For fields up to 3 V/m, the increase in the horizontal high-frequency RMS jitter is typically less than 3 ps RMS of jitter, added using the square-root-of-the-sum-of-the-squares method. An example follows:  
If an 80C01–CR operating in clock-recovery trigger mode exhibits 3.5 ps RMS of edge jitter, with no EMC field applied and for an ideal jitterless input, then for applied fields up to 3 V/m the edge jitter, degradation would typically result in a total RMS jitter of:  
$$Jitter \leq \sqrt{3.5 ps^2 + 3 ps^2} = 4.61 ps$$
- <sup>5</sup> Performance Criterion C applied at the 70%/25 cycle Voltage-Dip and the 0%/250 cycle Voltage-Interruption test levels (IEC 61000-4-11). If the instrument powers down upon a voltage dip or interruption, it will take longer than ten seconds to reboot.

- <sup>6</sup> With an 80E01 Electrical Sampling module, up to 15 mV<sub>RMS</sub> random noise is allowed when the instrument is subjected to fields and signals as defined in the IEC 61000-4-3 and IEC 61000-4-6 tests.

### **Australia / New Zealand Declaration of Conformity – EMC**

Complies with the EMC provision of the Radiocommunications Act per the following standard, in accordance with ACMA:

- CISPR 11:2003. Radiated and Conducted Emissions, Group 1, Class A, in accordance with EN 61326-1:2006 and EN 61326-2-1:2006.

## Safety Compliance

### EC Declaration of Conformity – Low Voltage

Compliance was demonstrated to the following specification as listed in the Official Journal of the European Communities:

Low Voltage Directive 2006/95/EC.

- EN 61010-1: 2001. Safety requirements for electrical equipment for measurement control and laboratory use.

### U.S. Nationally Recognized Testing Laboratory Listing

- UL 3111-1, First Edition, 2<sup>nd</sup> Amendment. Standard for electrical measuring and test equipment.

### Canadian Certification

- CAN/CSA-C22.2 No. 61010.1–97. Safety requirements for electrical equipment for measurement, control, and laboratory use. Part 1.

### Additional Compliances

- IEC 61010-1: 2001. Safety requirements for electrical equipment for measurement, control, and laboratory use.

### Equipment Type

Test and measuring equipment.

### Safety Class

Class 1 – grounded product.

### Pollution Degree Description

A measure of the contaminants that could occur in the environment around and within a product. Typically the internal environment inside a product is considered to be the same as the external. Products should be used only in the environment for which they are rated.

- Pollution Degree 1. No pollution or only dry, nonconductive pollution occurs. Products in this category are generally encapsulated, hermetically sealed, or located in clean rooms.
- Pollution Degree 2. Normally only dry, nonconductive pollution occurs. Occasionally a temporary conductivity that is caused by condensation must be expected. This location is a typical office/home environment. Temporary condensation occurs only when the product is out of service.
- Pollution Degree 3. Conductive pollution, or dry, nonconductive pollution that becomes conductive due to condensation. These are sheltered locations where neither temperature nor humidity is controlled. The area is protected from direct sunshine, rain, or direct wind.
- Pollution Degree 4. Pollution that generates persistent conductivity through conductive dust, rain, or snow. Typical outdoor locations.

## **Pollution Degree**

Pollution Degree 2 (as defined in IEC 61010-1). Note: Rated for indoor use only.

## **Installation (Overvoltage) Category Descriptions**

Terminals on this product may have different installation (overvoltage) category designations. The installation categories are:

- Measurement Category IV. For measurements performed at the source of low-voltage installation.
- Measurement Category III. For measurements performed in the building installation.
- Measurement Category II. For measurements performed on circuits directly connected to the low-voltage installation.
- Measurement Category I. For measurements performed on circuits not directly connected to MAINS.

## **Overvoltage Category**

Overvoltage Category II (as defined in IEC 61010-1)

## Environmental Considerations

This section provides information about the environmental impact of the product.

### Product End-of-Life Handling

Observe the following guidelines when recycling an instrument or component:

**Equipment Recycling.** Production of this equipment required the extraction and use of natural resources. The equipment may contain substances that could be harmful to the environment or human health if improperly handled at the product's end of life. In order to avoid release of such substances into the environment and to reduce the use of natural resources, we encourage you to recycle this product in an appropriate system that will ensure that most of the materials are reused or recycled appropriately.



This symbol indicates that this product complies with the applicable European Union requirements according to Directives 2002/96/EC and 2006/66/EC on waste electrical and electronic equipment (WEEE) and batteries. For information about recycling options, check the Support/Service section of the Tektronix Web site ([www.tektronix.com](http://www.tektronix.com)).

**Mercury Notification.** This product uses an LCD backlight lamp that contains mercury. Disposal may be regulated due to environmental considerations. Please contact your local authorities or, within the United States, refer to the E-cycling Central Web page ([www.eiae.org](http://www.eiae.org)) for disposal or recycling information.

**Perchlorate Materials.** This product contains one or more type CR lithium batteries. According to the state of California, CR lithium batteries are classified as perchlorate materials and require special handling. See [www.dtsc.ca.gov/hazardouswaste/perchlorate](http://www.dtsc.ca.gov/hazardouswaste/perchlorate) for additional information.

### Restriction of Hazardous Substances

This product has been classified as Monitoring and Control equipment, and is outside the scope of the 2002/95/EC RoHS Directive.

# Preface

## Documentation

This manual describes the installation and operation of the DSA8200 Digital Serial Analyzer along with basic operation and concepts. For more detailed information, see the online help on your instrument.

---

**NOTE.** *The screen images in this manual may differ slightly from other versions of product software.*

---

Additional information is available through a variety of sources. The following table points to the location of different types of information available for this product.

Type of information	Location
Unpacking, installation, operation and overviews	Quick Start User Manual
In-depth operation, UI help, programming help	Instrument online help
Performance verification and specifications	Product documentation CD
Product software	Product software CD <a href="http://www.tektronix.com/software">www.tektronix.com/software</a>
Self service	Service manual
PDF files of instrument and modules manuals	Product software CD <a href="http://www.tektronix.com/manuals">www.tektronix.com/manuals</a>



## Conventions Used in this Manual

The following icons are used throughout this manual.

Rear panel  
power

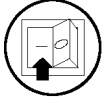

Front panel  
power



Connect  
power

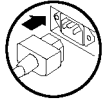

Network

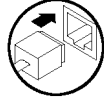

PS2

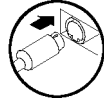

SVGA

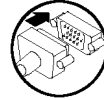

USB

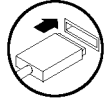



## Key Features

The DSA8200 Digital Serial Analyzer is a high-speed, precision sampling system that finds use in validation and conformance testing and impedance verification for:

- High-performance semiconductor/computer applications, such as semiconductor testing, TDR characterization of circuit boards, IC packages and cables, and high-speed serial digital data communications.
- High-performance communications applications, such as design evaluation and manufacturing test of datacom and telecom components, transceiver subassemblies, and transmission systems.

The instrument includes a user interface that runs on the Microsoft Windows XP Professional operating system as a windowed application. You operate the instrument using front-panel controls with the mouse and keyboard or with the touch screen.

Features Include:

- Industry-leading waveform acquisition and measurement rate, with Sample, Envelope, and Average acquisition modes.
- Support for up to six sampling modules (two large and four small modules). Up to eight inputs can be active at a time.
- Support for integrated optical and/or electrical signal pick-off and clock recovery, enabling accurate triggering on optical and/or electrical communication signals.
- Support for optical modules with several integrated, selectable reference receivers, which eliminates the need for a multitude of add-on reference receivers.
- Full programmability, with an extensive GPIB-command set and a message-based interface.
- True differential TDR, with fast step (15 psec reflected risetime) when used with a TDR-capable 80E10 sampling module.
- Industry-leading trigger bandwidth (12+ GHz) when using the built-in prescaler.
- Support of both telecom (SONET and SDH) and datacom (Fibre Channel, Infiniband, and Gigabit Ethernet) optical communication standards.
- Powerful built-in measurement capability, including histograms, mask testing, and automatic measurements.
- Automatic measurements operate on Pulses, RZ eye patterns, and NRZ eye patterns.
- DC to 65 GHz optical bandwidth; DC to 70+ GHz electrical bandwidth, with up to 12.5 GHz triggering. Bandwidth is determined by the capabilities of the installed modules.
- Low jitter (200 fs typical) in phase reference modes with the 82A04 Phase Reference module.
- FrameScan acquisition for isolating data-dependent failures during conformance/performance testing and for examining very low-level repetitive signals.
- Pattern (frame) triggering with the 80A06 PatternSync Trigger module.
- Jitter, Noise, and BER analysis with the 80SJNB Essentials application. With the 80SJNB Advanced application, features for de-embedding of the fixture, channel emulation, and FFE/DFE equalizer support are also added.
- Improved acquisition throughput and timing accuracy using the PatternSync Trigger module in conjunction with FrameScan.
- Support for optical conformance testing of SONET/SDH signals (including the various forward error correction rates for these telecom rates) from 155 Mbps to 43 Gb/s, FibreChannel signals, and 1, 2, 10, and 100 Gigabit Ethernet signals as well as 2.5 Gb/s Infiniband signals. Support for conformance testing rates is determined by the specific modules that are installed.
- High precision time base with two modes of operation, locked and short-term jitter-optimized.

- Negligible long-term jitter degradation (<0.1 ppm), which substantially improves the ability to view signals that are delayed far from the trigger point without distortion.
- Improved short-term and long-term trigger jitter.
- A gated trigger option (Option GT) that lets you disable or enable (gate) triggering based on a TTL signal that you connect to the instrument rear panel. This option allows you to use recirculating buffers as part of your test setup to simulate the effects of very long optical links that are typical of undersea cables and long terrestrial links.
- Analysis and connectivity tools that enable the instrument to be controlled from a variety of local and remote environments and to share data with other commercially available analysis programs.
- Predefined, built-in masks in addition to the user-defined masks.
- A large 10-inch color display that supports color grading of waveform data to show sample density.
- An intuitive user interface (UI), with built-in online help.

# Install Your Instrument

Unpack the instrument and check that you received all items listed as Standard Accessories. Recommended accessories and probes, instrument options, and upgrades are listed in the online help. Check the Tektronix Web site ([www.tektronix.com](http://www.tektronix.com)) for the most current information.

## Standard Accessories

<b>Accessory</b>	<b>Tektronix part number</b>
DSA8200 Digital Serial Analyzer Quick Start User Manual	071-2047-xx
Certificate of Traceable Calibration for product at initial shipment	Not orderable
Business reply card	Not orderable
Microsoft Windows compatible keyboard	119-B146-00
Microsoft Windows compatible mouse	119-6936-00
Instrument front cover	200-4519-00
Accessory pouch	016-1441-00
Touch screen styluses (2)	119-6107-00
ESD wrist strap with 6 foot coiled cord	006-3415-04
DSA8200 Product Documentation Kit (CD)	020-2543-xx
DSA8200 Online Help (part of application software)	Not orderable
DSA8200 Programmer Online Guide (part of application software)	Not orderable
DSA8200 Product Software Kit	020-2734-xx
DSA8200 Operating System Restore Kit	020-2980-xx
Serial numbers B030000 and above	
8000 Demo Applications Software CD	020-2480-xx
Power cord	Type dependent on selection during order placement

## Operating Considerations

The following information lists the specifications related to the operation of the mainframe. Refer to the *DSA8200 Specifications and Performance Verification* manual for a complete list of specifications.

### Mechanical

**Clearance:**

- Top, Front, and Rear: 0 in (0 mm)
- Sides: 2 in (51 mm)
- Bottom: 0.75 in (19 mm)

**Weight:**

- 19.5 kg (43.0 lb.). This does not include any accessories or modules.

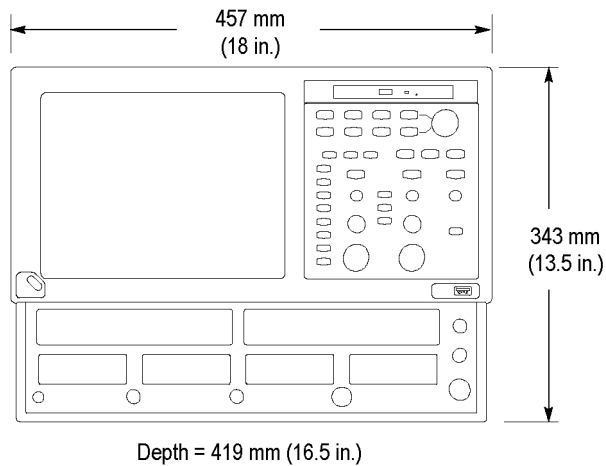

### Environmental

Temperature	10 °C to +40 °C
Relative humidity	20% to 80%, with a maximum wet bulb temperature of 29 °C at or below +40 °C
Altitude	3,000 m (9,843 ft.)

### Power Supply

Source voltage and Frequency	100 - 240 V <sub>RMS</sub> ±10%, 50 - 60 Hz or 115 V <sub>RMS</sub> ±10%, 400 Hz
Power Consumption	600 watts Typically, 240 watts (fully loaded); 160 watts (mainframe with no modules)

### Input Connectors

Trigger Direct Input range	±1.5 V (DC + peak AC) maximum input voltage
----------------------------	---

---

Trigger Prescaled Input absolute maximum input (typical)	$\pm 2.5 V_{p-p}$
External 10 MHz Reference Input	500 mV <sub>p-p</sub> to 5 V <sub>p-p</sub> AC coupled into 1 k $\Omega$ , $\pm 5 V$ maximum
Gated Trigger Input non-destruct levels (Option GT equipped mainframes)	$\pm 5 V$ maximum

## Installing Modules



**CAUTION.** To prevent damage to modules, do not transport or ship the instrument with modules installed. Modules are also sensitive to electrostatic discharge (ESD). To avoid ESD damage, always use an ESD wrist strap when installing or removing modules and when connecting signals to the module inputs. Never install or remove modules while the instrument is powered on.

1. Always use an ESD wrist strap (provided) when installing and removing modules.
2. You can install up to two large sampling modules and four small modules for a total of 8 inputs.

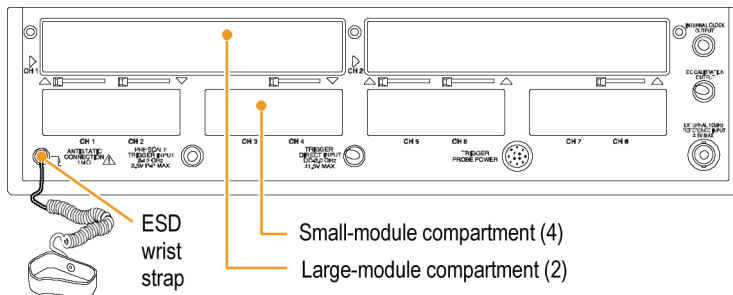

Following are some typical module installations illustrating the interaction between large compartment channels and small compartment channels.

**NOTE.** A large compartment module that only derives power from the compartment does not use any small compartment input channels.

Eight channels: No large and four small modules



Six channels: Two large modules and two small modules



Seven channels: One large module, installed in CH3 compartment, and three small modules

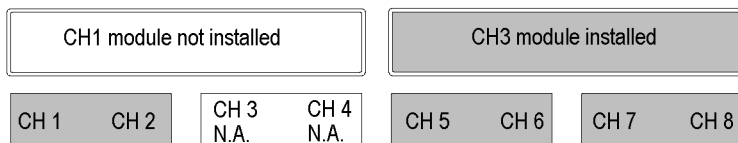

Seven channels: One large module, installed in CH1 compartment, and three small modules





## Powering the Instrument On and Off

1. Insert AC power cord.
2. Toggle the mains switch to on.

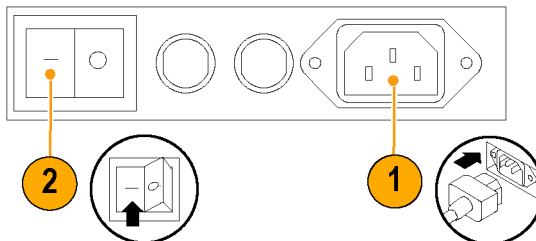

3. Use the front panel power button to switch the instrument on and off.

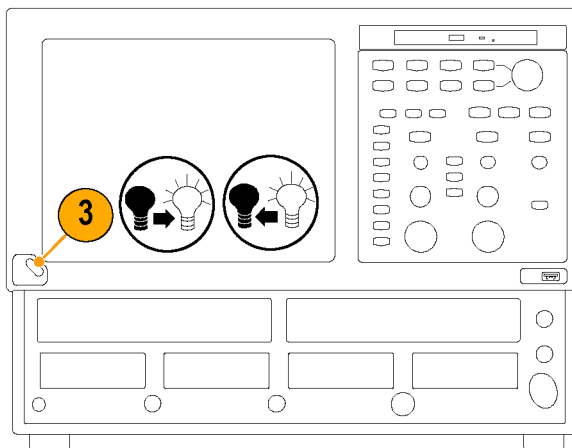

### Quick Tip

- When turning off the instrument, Microsoft Windows and all applications automatically shut down before the instrument powers off.



**CAUTION.** To prevent damaging the modules, do not install or remove any modules while the instrument is powered on.

## Adding a Second Monitor

You can operate the instrument while using Microsoft Windows and installed applications on an external monitor. Use the Settings tab in the Windows Display Properties dialog box to set up a dual-monitor configuration. Both the oscilloscope and the second monitor must have the color setting set to True Color.

1. Power off the instrument.

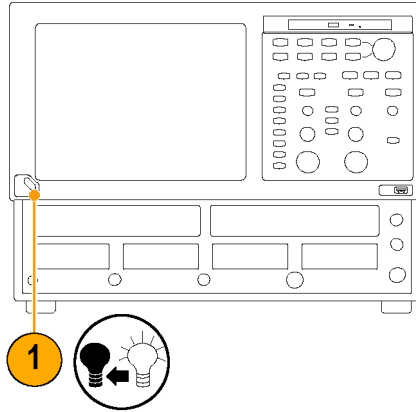

2. Connect a video cable (not supplied) from the SVGA out dual monitor display video port on the back of the instrument to the external monitor.

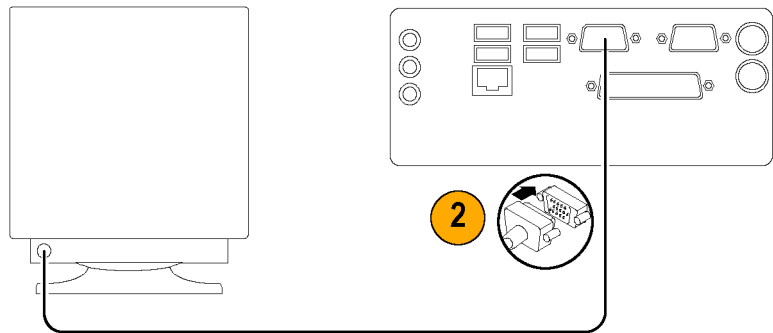

3. Power on the instrument.
4. Power on the external monitor.

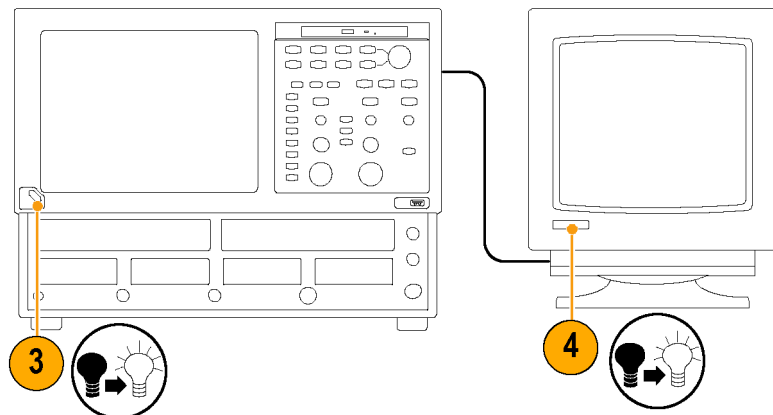

5. In the Start menu, select **Control Panel**.

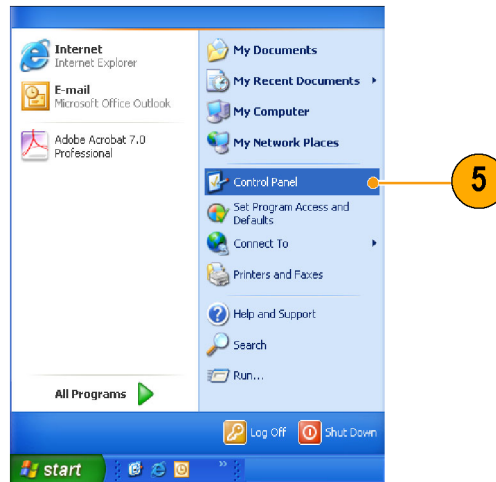

6. Select **Display**.

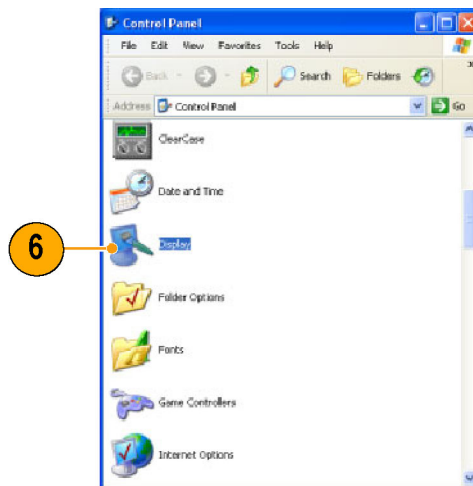

7. In the Display Properties window, select the **Settings** tab.
8. Click the grayed out external monitor (2) and drag it to the left of monitor 1.
9. Select **Yes** when you are prompted to enable the new monitor.
10. Click **OK** and **Apply**. You will then be prompted to restart your system so the changes can take effect.

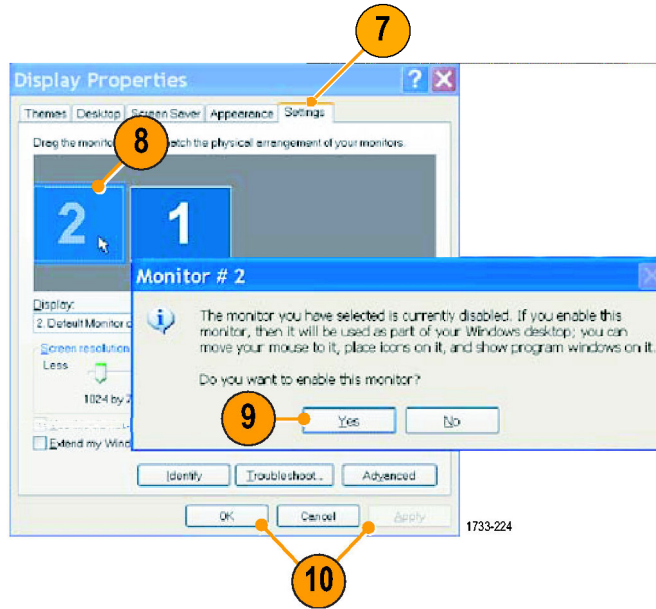

## Changing the Windows Language

Use the following procedure to change the Windows language from English to one of your choice. This procedure does not change the language in the TekScope application. Before you begin, minimize the TekScope application.

1. In the Start menu, select **Control Panel**.
2. Select **Regional and Language Options**.

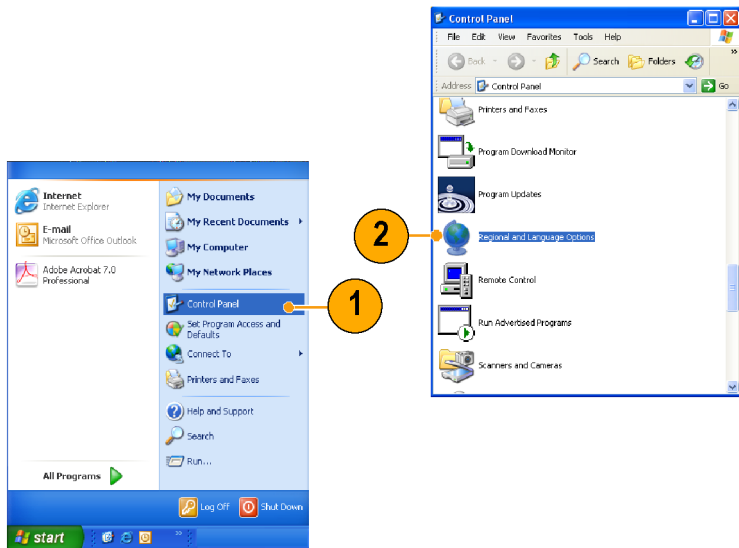

3. Select your location.
4. Select your language preference. The time and numbering system of your selected locale will adjust automatically to this selection.
5. Select the Languages tab to further specify your preferences. For more details on customizing your language options, see your Windows XP help.

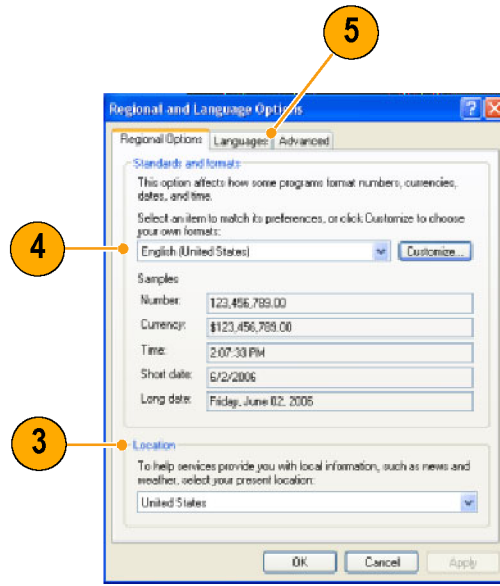



# Getting Acquainted with Your Instrument

## Front Panel

The front panel of your instrument gives you access to the module compartments and the control panel.

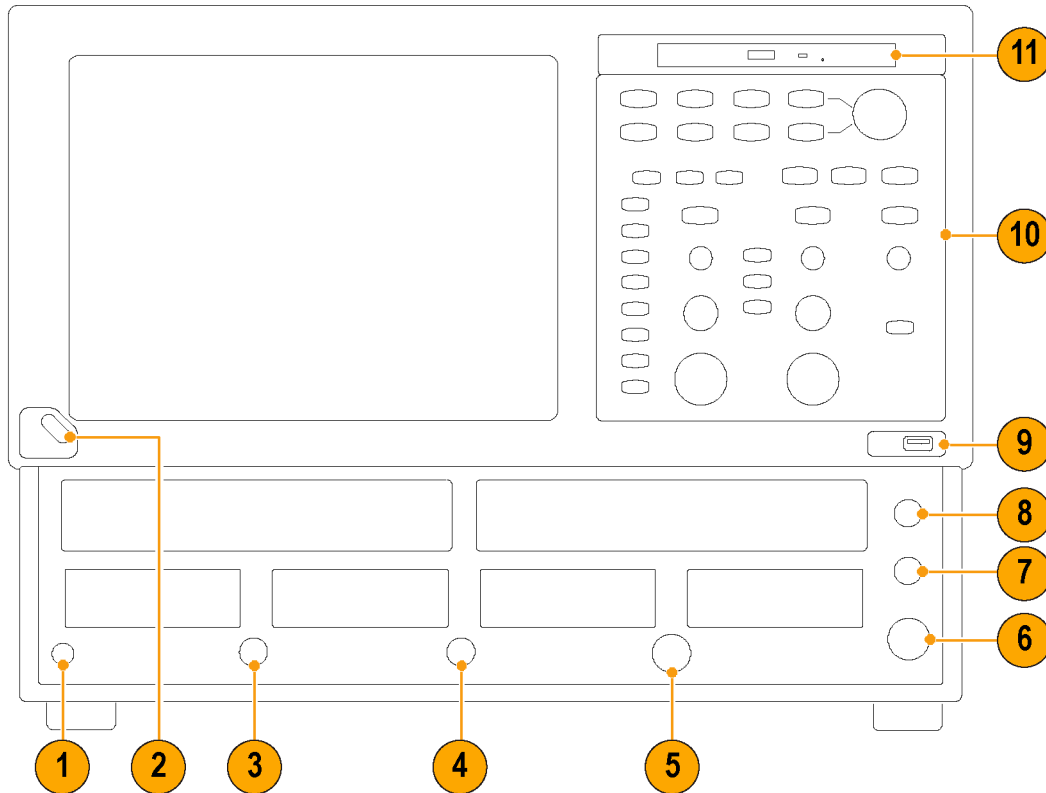

1. Antistatic connection 1 M $\Omega$  terminal.
2. On/Off switch.
3. Trigger prescale input.
4. Trigger direct input.
5. Trigger probe power.
6. External 10 MHz reference input.
7. DC calibration output.
8. Internal clock output.
9. USB port.
10. Control panel.
11. CDRW/DVD drive.

## Control Panel

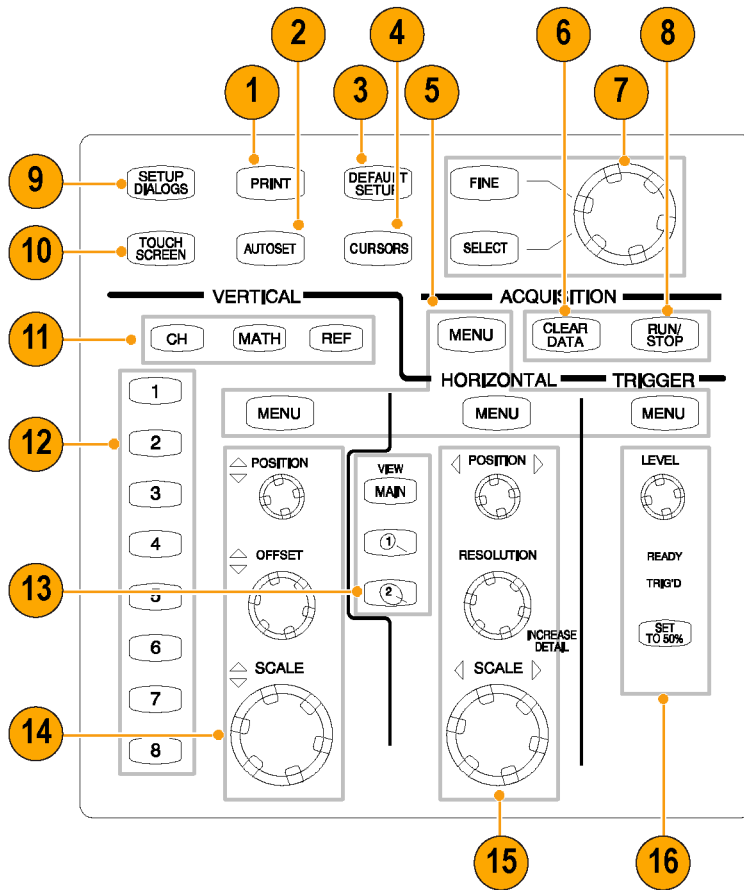

1. Access print dialog box for printing the display.
2. Optimize instrument settings for selected channels.
3. Quickly return to instrument-default control settings.
4. Display measurement cursors and assign the knob and SELECT buttons to control them.
5. Menu buttons quickly access the setup dialog box for more detailed setup.
6. Clear all channel waveforms at once.
7. Adjust most control fields in setup dialogs. Press the SELECT button to switch among fields. Press the FINE button to toggle between normal and fine adjustment.
8. Start and stop acquisition.
9. Display the cluster of Setup dialog boxes for comprehensive setup of the instrument.
10. Toggle the touch screen on and off. Use the touch screen to control UI when you have not installed a mouse.
11. Select a waveform type, Channel, Reference, or Math, to display or adjust on screen (selected button lights).
12. Select among displayed waveforms or display and select a waveform. Press selected waveform to turn it off. Button lights indicate displayed and selected waveforms.



13. Select among displayed timebase views or display and select a timebase view. Press selected view to turn it off (except main, which is always on).
14. Vertically scale, position, and offset selected waveform.
15. Horizontally scale, position, and set record length of selected waveform.
16. Set trigger level and use lights to monitor trigger state.

## Rear Panel

The rear panel of your instrument allows you access to input and output connectors and the AC input.

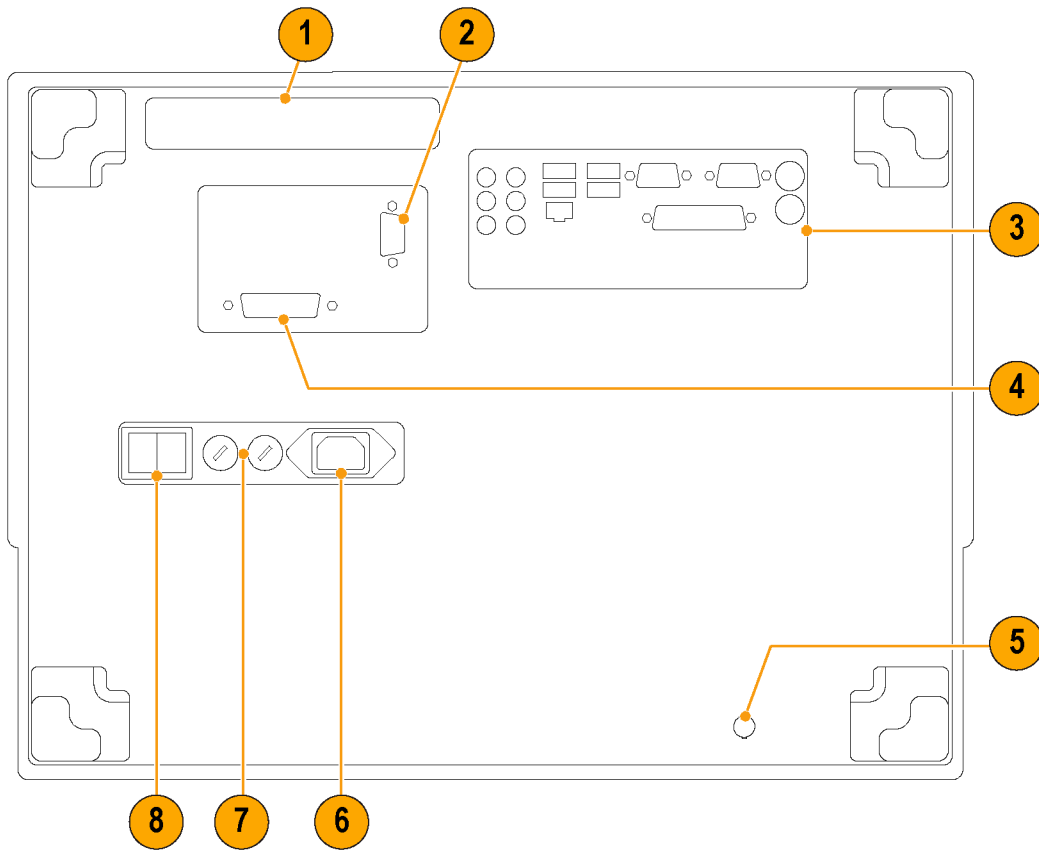

1. Removable hard drive.
2. Scope VGA output for instrument display.
3. Computer I/O panel.
4. GPIB port. The instrument is factory set to be a GPIB device (slave), allowing you to control the instrument via the GPIB port. You can change the instrument to be a GPIB controller (master), allowing you to control other devices via the GPIB port. Refer to the online Programmer Guide installed on the instrument.
5. Gated trigger Option GT.
6. AC input.
7. Fuses.
8. Mains power switch.

## Computer I/O Panel

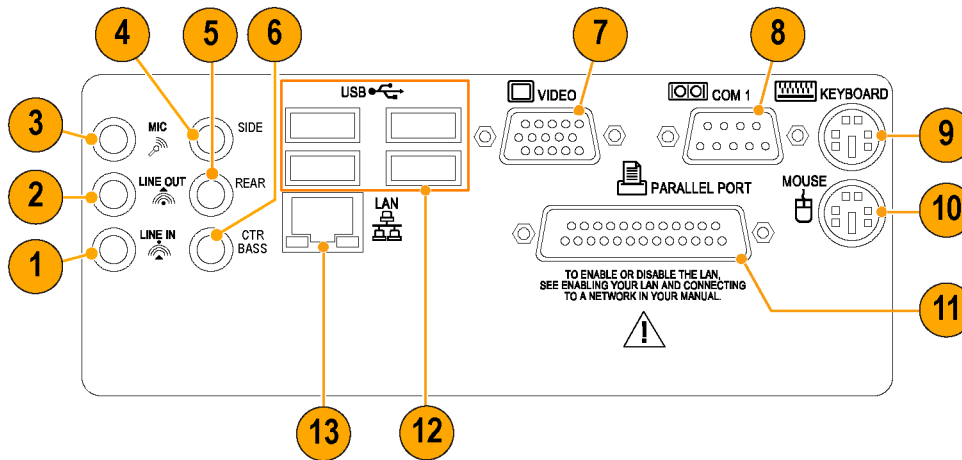

1. Audio line in.
2. Audio line out.
3. Audio line in (microphone).
4. Side surround sound.
5. Rear surround sound.
6. Center Bass surround sound.
7. SVGA out for dual-monitor display.
8. COM 1.
9. PS2 (keyboard).
10. PS2 (mouse).
11. Parallel port.
12. USB ports.
13. LAN.

## Interface

The menu bar provides access to commands that control all of the instrument features and functions. The toolbar provides access to the most common features.

Hovering the cursor over a button or setting displays a brief description of its function, called a tooltip.

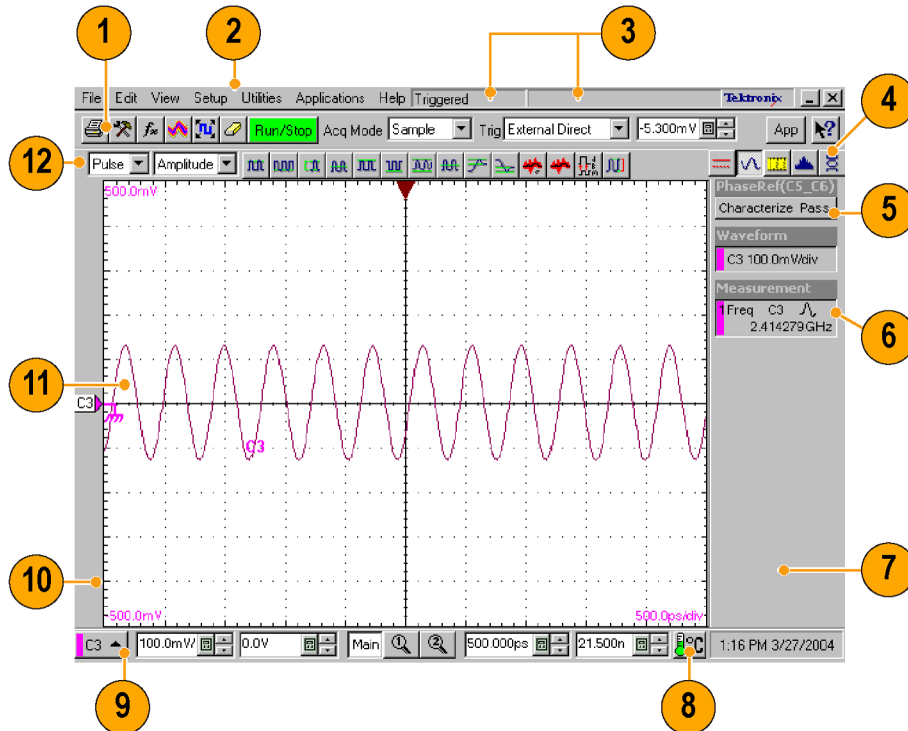

1. Tool Bar. Access to key features: printing, setup dialogs, math setup, waveform database, autoset, clear data, acquisition mode, triggering, and applications.
2. Menu Bar. Access to data I/O, printing online help system, and setup functions.
3. Status Bar. Trigger status and waveform count.
4. Readout Bar. Toggle individual readout on and off by clicking its button.
5. Phase Reference Status. Indicates the characterization status of the phase reference module.
6. A Readout. Right click any readout to display a short-cut menu providing access to often-used setup controls and properties for the features associated with the readout.
7. Readouts. Display up to five readouts in this area; select readouts from the Readout Bar.
8. Compensation Indicator. Indicates the compensation status of modules and mainframe.
9. Controls Bar. Quick access to waveforms and timebases for display, and to their scale, offset, and position controls for adjustment.
10. Waveform Bar. Access to waveform selection (click), waveform position (drag), and waveform properties (right-click).
11. Display. Live, reference, and math waveforms display here, along with cursors and masks to analyze them.
12. Measurements Bar. Access to automated measurements by signal type and category; click measurement buttons to measure the selected waveform.

## Display - Single Graticule View

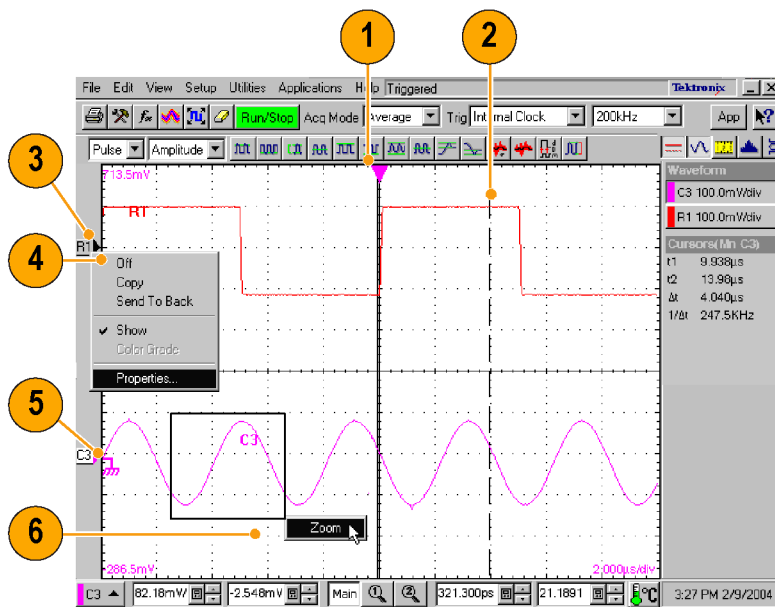

1. Drag the Horizontal Reference to move the point around which the horizontal scaling expands and contracts the waveforms.
2. Drag cursors to measure waveforms on screen.
3. Drag the waveform icon vertically to position waveform.
4. Right-click on a waveform or its icon for access to often used setup controls and properties.
5. Drag ground reference icon to add offset to a waveform.
6. Drag across the waveform area to zoom the boxed waveform segment to full screen width.

## Display - Multiple Views

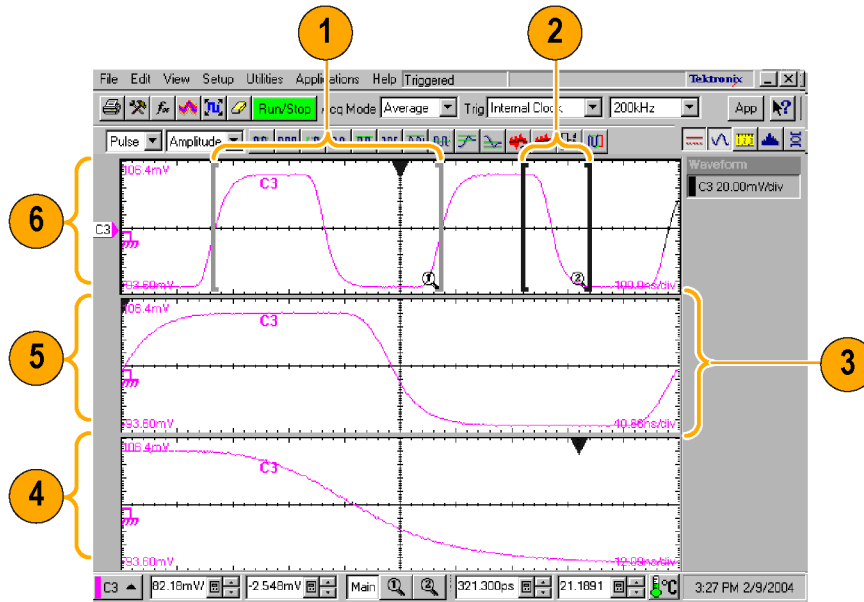

1. Drag the markers to enclose the portion of waveform to appear in Mag1 View.
2. Drag the markers to enclose the portion of waveform to appear in Mag2 View.
3. Drag the border between graticules to vertically size Main, Mag1, and Mag2 Views.
4. Mag2 View.
5. Mag1 View.
6. MAIN View.

## Accessing Online Help

In-depth information about all the features of your instrument is available in the online help.

For a brief description of controls, move your mouse pointer and let it rest over a control, such as a menu name, a menu item, tool-bar button, or tool-bar readout. The help system displays a short definition or a label (tooltips) of the control.

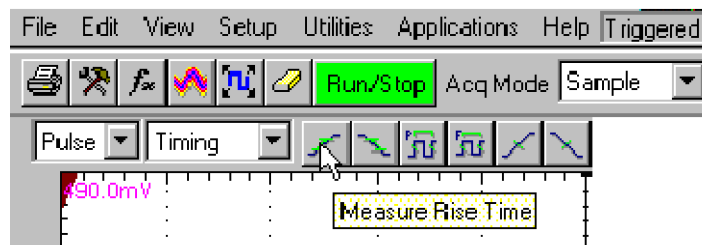

For a more detailed description, click the What's This? button in the main display or in a dialog box.

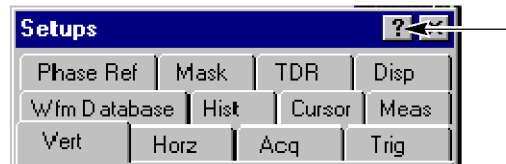

After clicking the What's This? button, click the control you want described. A popup box describes the control.

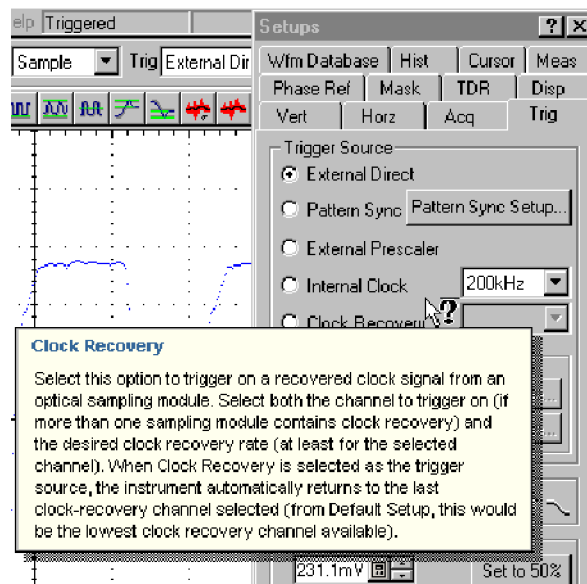

For in-depth, contextual overviews, most dialog boxes have a Help button. Click the button to open the help system with an overview of the dialog box that is currently displayed.

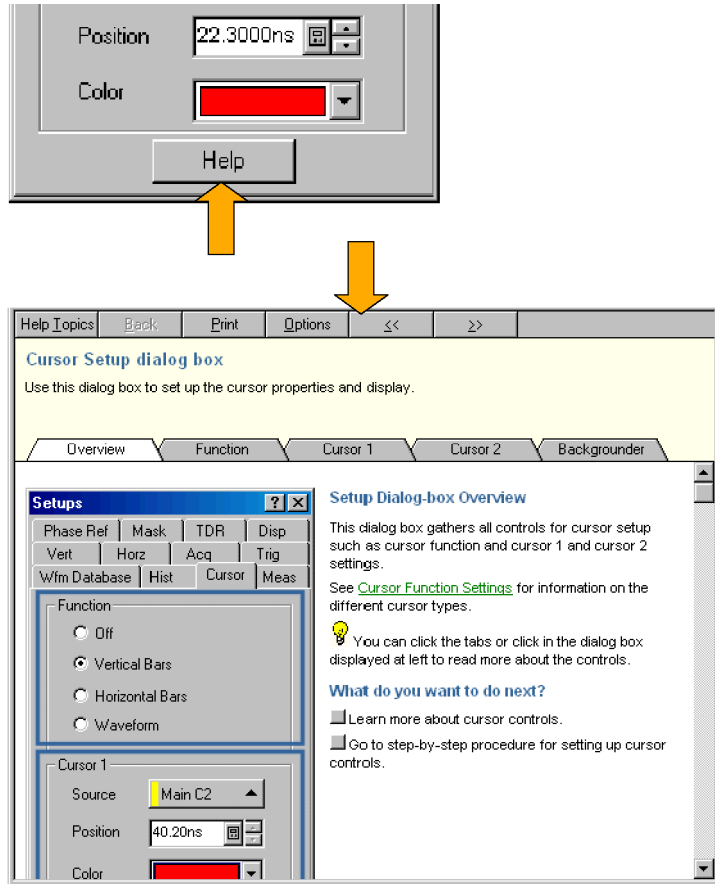

You can search for in-depth help from the application menu bar: select **Help** and then select **HELP Contents & Index**.





# Inspect Your Instrument

Use the following procedure to verify the functionality of your instrument. For a complete performance verification, see the Performance Verification section in the optional service manual.

## Verify Internal Diagnostics Pass

1. Install all modules to be diagnosed.
2. Power on the instrument and wait 20 minutes for the warm-up period.

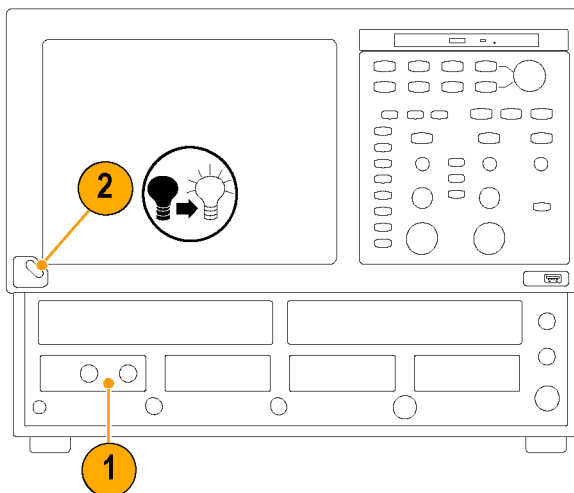

3. From the **Utilities** menu, select **Diagnostics...**

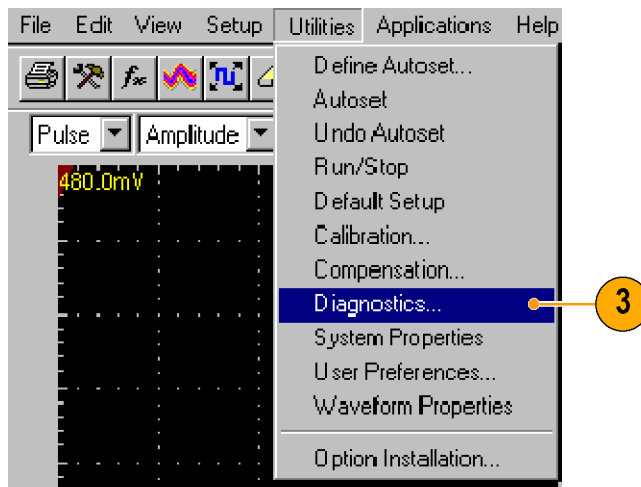

4. Select the **Subsystem Level** tab.
5. Select all the entries by clicking the first entry **Control Proc** and dragging down to select the rest. All entries should be highlighted.
6. In the **Run** box, leave **Loop** and **Halt on Failure** unchecked.
7. Click **Run**.
8. Verify that **Pass** appears as **Status** in the dialog box when the diagnostics complete. If diagnostic failures occur, contact your local Tektronix service personnel.

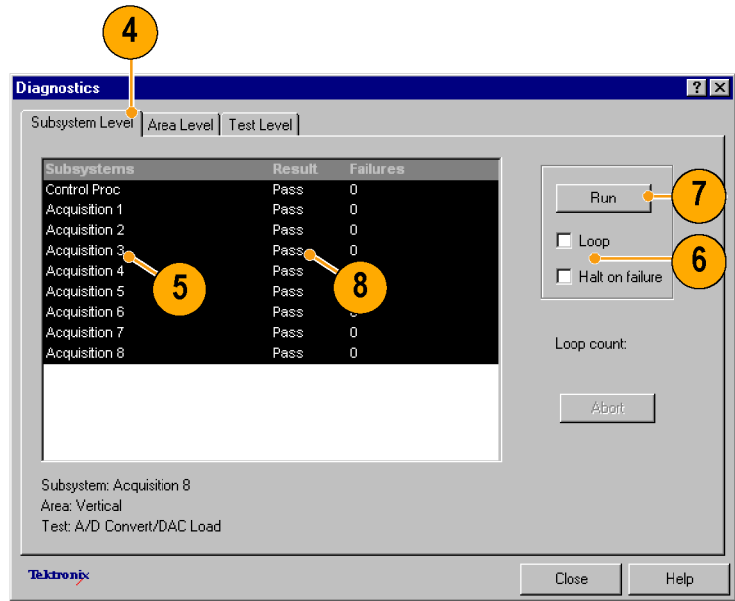

## Optimizing Measurement Accuracy

This instrument can compensate itself and the installed sampling modules, optimizing the internal signal path used to acquire the waveforms you measure. Compensation optimizes the capability of the instrument to make accurate measurements at the ambient temperature.

**NOTE.** When installing a module or moving a module to another compartment, you must power on the instrument and allow the temperature (of the instrument and module(s)) to reach a stable equilibrium (normally 20 minutes). Then, run Compensation from the Utilities menu. This ensures the instrument meets the published specifications.

You must save the compensation results or they will be lost when the instrument is powered down.

### Signal Path Compensation

This procedure compensates the signal path of each installed module (for the current temperature) to enhance measurement results.

Use this procedure for any of the following conditions:

- A module has been added to the instrument, an extender cable has been added or removed from a module, or a module has been moved to another compartment.
- The temperature has changed more than 5 °C since the last signal path compensation.

When making measurements at vertical scale settings less than or equal to 5 mV/div, perform the signal path compensation once a week. Failure to do so may result in the instrument not meeting warranted performance levels at those volts/div settings.

1. Install all modules to be compensated.
2. Install all terminations and dustcovers.  
Failure to install the 50  $\Omega$  terminations on electrical inputs can yield erroneous compensation failures or results.
3. Power on the instrument and wait 20 minutes for the warm-up period.

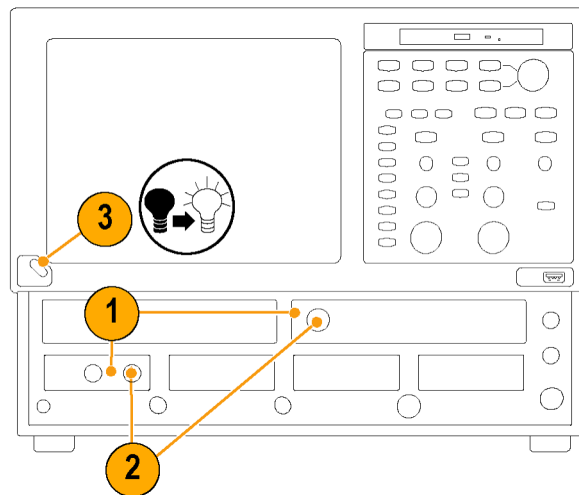

4. Select **Compensation...**

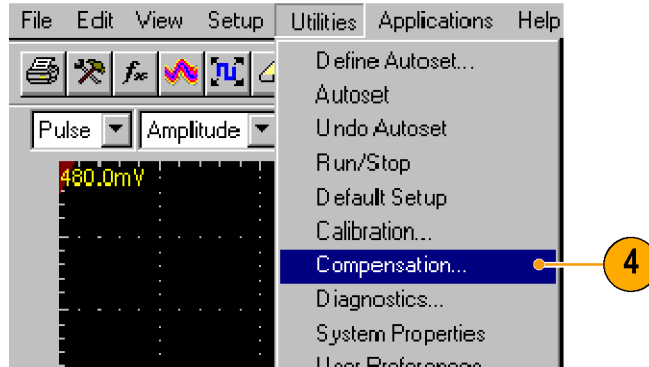

5. In the Compensation dialog box, note that the main instrument (mainframe) and sampling modules are listed. The temperature change from the last compensation is also listed.

6. Wait until the Status for all items you want to compensate changes from **Warm Up** to **Pass**, **Fail**, or **Comp Req'd**.

7. Under Select Action, select **Compensate and Save** (default).

8. From the top dropdown list, choose **All** (default selection) to select the main instrument and all its modules as targets to compensate.

9. Click the **Execute** button.  
Follow the instructions to disconnect inputs and install terminations that appear on screen; be sure to follow static precautions (see the user information for your sampling module) when following these instructions.

10. Verify that the compensation routines pass.  
If the status is **Fail**, rerun the compensation. If **Fail** status continues and you have allowed warmup to occur, the module or main instrument may need service.

11. Use the Compensation Indicator Button to display or hide the indicator on the main display. Green indicates all modules have been successfully compensated. Red indicates one or more modules require compensation.

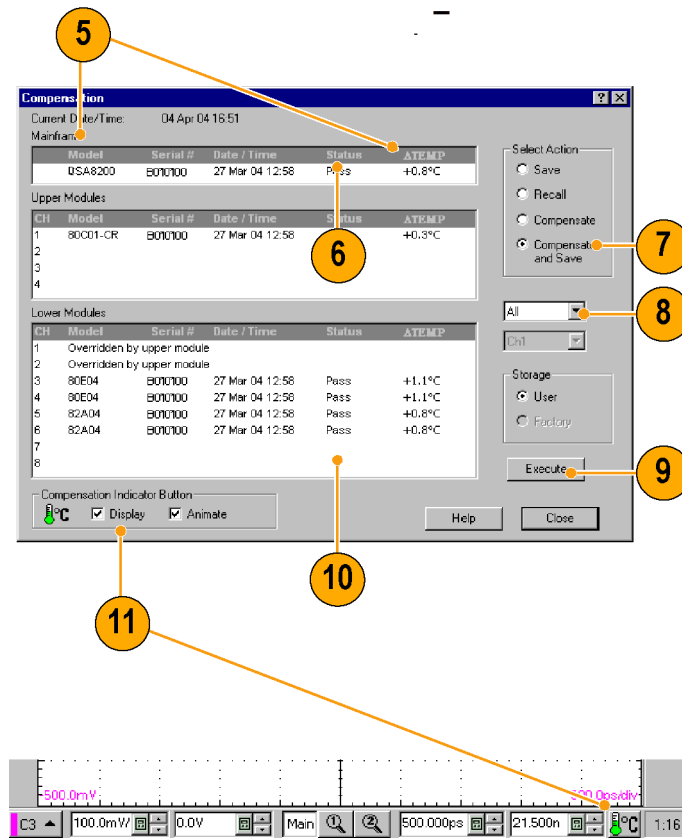

## Perform Dark-Level and User Wavelength Gain Compensations

Performing a dark-level compensation maximizes the accuracy of the extinction ratio and other optical automatic measurements you take. Performing a User Wavelength Gain compensation optimizes an optical channel for your custom input signal.

**NOTE.** Dark-level compensation performs a subset of the module compensation process. It is designed to be fast so it can be performed frequently, just before measurements are taken. This compensation is not saved and is only valid for the selected bandwidth or filter path and the internal optical power meter.

You should perform the procedure Signal Path Compensation to compensate all vertical bandwidth and filter selections. (See page 25, Signal Path Compensation.)

Use the following procedure to perform either compensation; this procedure applies only to optical modules.

1. Install at least one optical sampling module in the instrument to be dark-level calibrated. Set the acquisition system to run continuously.

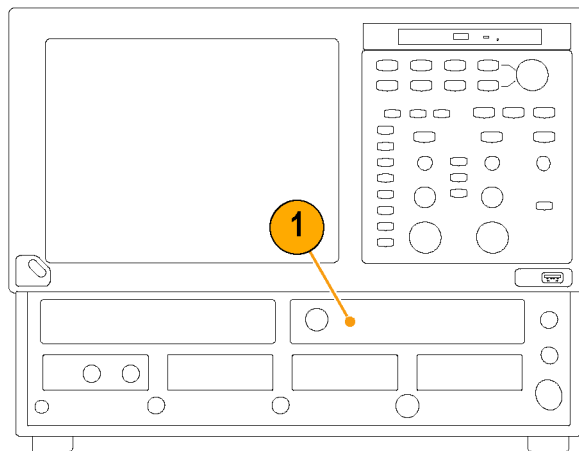

2. Use the Vertical buttons to select the channel to be compensated.

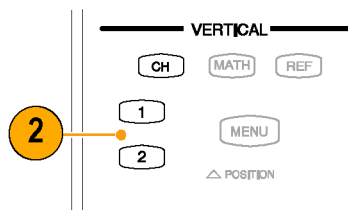

- From the application menu bar, click **Setup**, and then click **Vertical**.

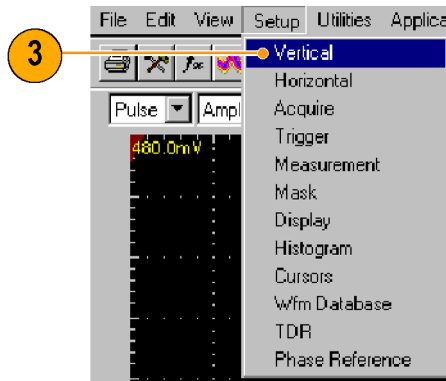

To run the Dark-Level compensation:

- In Vert Setup dialog box, click the **Dark Level** button under Compensation. Follow the instructions on screen. Repeat steps 2 and 4 for any additional optical channels you want to compensate.

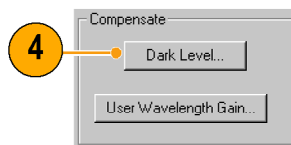

To run the User Wavelength Gain compensation (for custom input signals):

- Attach an optical signal, with a precisely known amount of optical power, to the optical module input. Use an independently-calibrated average optical power meter to measure this power precisely. Then connect the signal to the optical module using the same fiber cables.

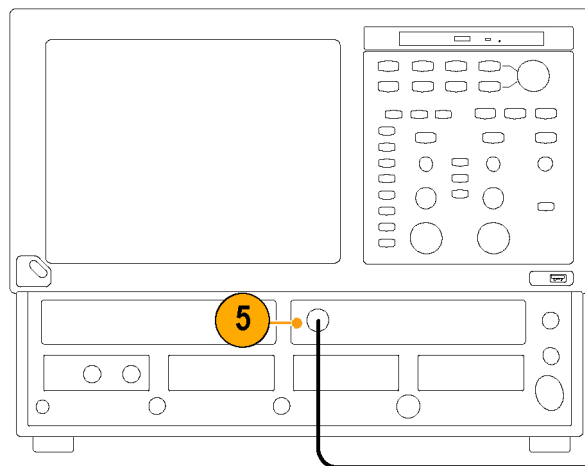

6. In Vert Setup dialog box, click the **User Wavelength Gain** button under Compensate. Follow the instructions on the screen.
7. In the User Wavelength Gain Compensation dialog box, set the wavelength and power of the signal to be applied to the channel.
8. Press the **OK** button to execute the compensation.

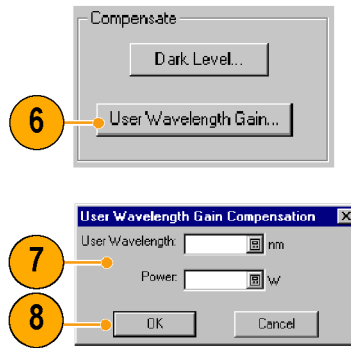

# Acquisition

This section contains concepts of and procedures for using the acquisition system. Detailed information is available in the online help.

## Setting Up Signal Input

Use front-panel buttons to set up your instrument to acquire the signal.



**CAUTION.** Sampling modules are inherently vulnerable to static damage. Always observe static-safe procedures and cautions as outlined in your sampling-module user manual.

1. Connect to the signal to be acquired using proper probing/connecting techniques. See the user manual for the sampling module you have chosen.
2. Connect an appropriate trigger signal to the instrument. (See page 37, *Triggers*.)

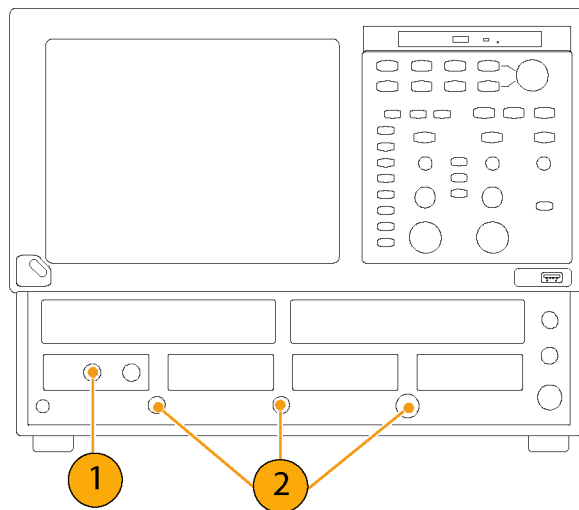

3. Push the **CH** button (turns amber) to assign the waveform buttons (1 – 8) to operate on channel waveforms, then select the proper waveform button.
 

A waveform button lights when its channel is on; when on but not selected, its button is lighted green; when on *and* selected, its button is lighted amber.

Pushing the **MATH** button assigns the waveform buttons to math waveforms. If no math waveforms are defined, the Define Math dialog box appears.

Push the **REF** button to assign the waveform buttons to reference waveforms. If no reference waveforms are defined, the Recall Waveform dialog box appears.

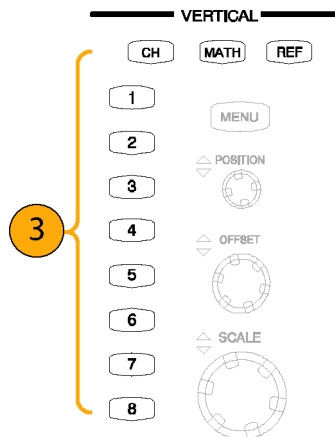



4. Use the Vertical **Offset** knob to adjust the selected waveform on the screen. Use the Vertical **Scale** and **Position** knobs to adjust the display.

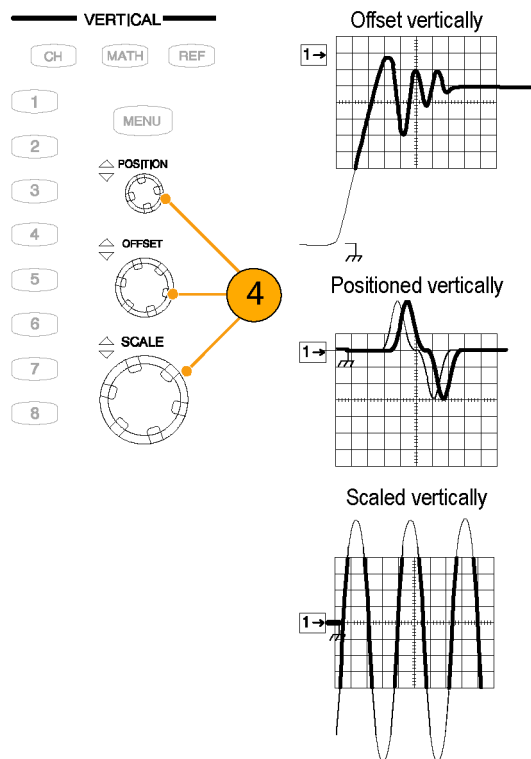

5. Push the **View Main** button to make sure that the main time base view is selected. Use horizontal knobs to scale and position the waveform on the screen and to set sample resolution.

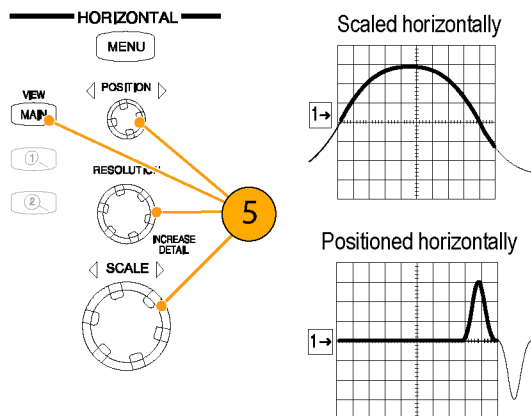

### Quick Tips

- You can click a waveform trace or its reference indicator with the mouse pointer (or touch screen) to select it.
- Push **AUTOSET** to quickly set up instrument parameters based on the input signal.
- Press **Set to 50%** in the Trigger controls, if required, to stabilize the display when using the Trigger Direct Input connector.

## Using Autoset

Use Autoset to quickly and automatically set up the instrument (vertical, horizontal, and trigger parameters) based on the characteristics of the input signal.

1. Push the **AUTOSET** button to execute an Autoset.

If you use Autoset when one or more channels are displayed, the instrument uses the selected channel for horizontal scaling. Vertically, all channels in use are individually scaled.

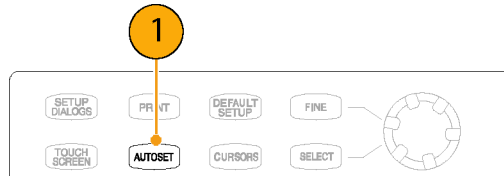

### Quick Tip

- Use the Define Autoset in the Utilities menu to display and change the Autoset properties.

## Using Default Setup

1. To quickly return to the factory default settings, push **DEFAULT SETUP**.

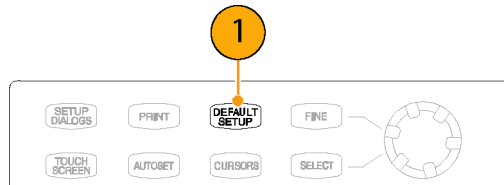

2. Click **Yes** to restore the settings.

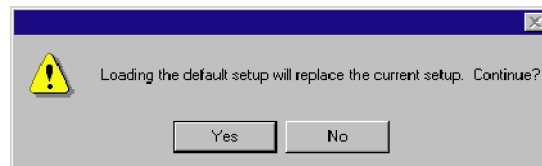

## Accessing the Setup Dialog Boxes

1. You can access the Setup dialog boxes by using the front panel buttons, the file menu, or the toolbar.

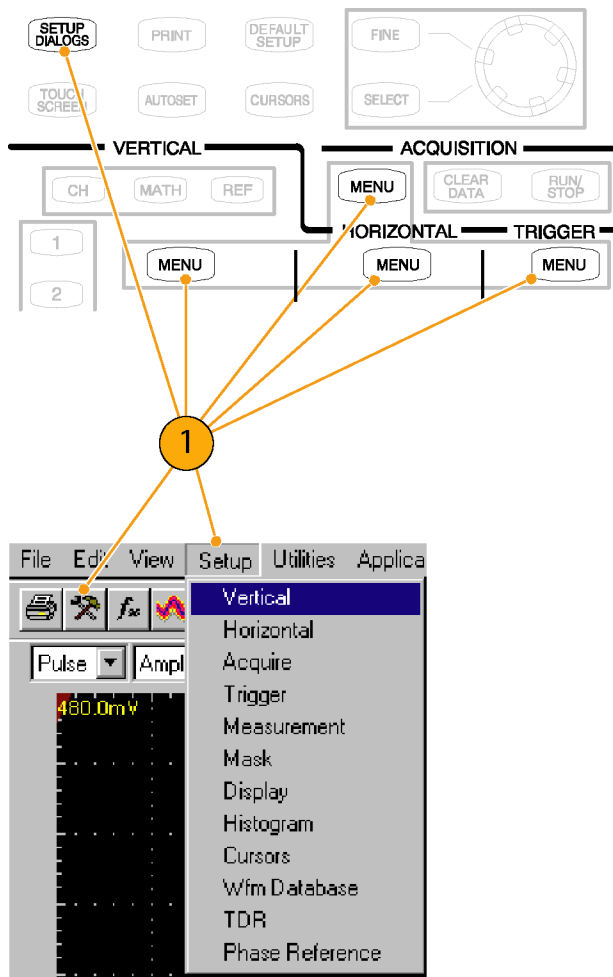

2. Click on the tabs to select among the setup dialog boxes.

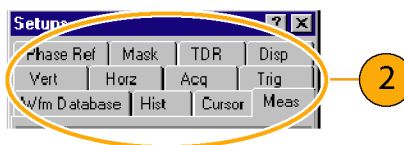

## Changing the Acquisition Mode

Use the procedure that follows to set the data-acquisition mode and specify acquisition start and stop methods.

1. Press the Acquisition **MENU** button to display the Acq Setup dialog box.

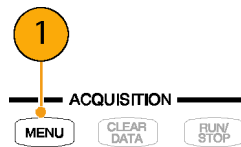

2. Select the acquisition mode.
3. For Average mode, enter the number of samples to average.
4. Set the Stop After mode and action by selecting one of the following options:

- Run/Stop Button Only
- Condition

5. If you selected Condition, choose a condition to stop on from the drop-down list. If the condition requires a count, enter a count.

6. Select a **Stop Action** action from the drop-down list. Choose from the following actions:

- None
- Print Screen to File
- Print Screen to Printer
- Save all Waveforms

Enter a filename if you selected **Print to File** or **Save all Waveforms**.

7. Select **Ring Bell** if you want an audio notice when the acquisition stops.

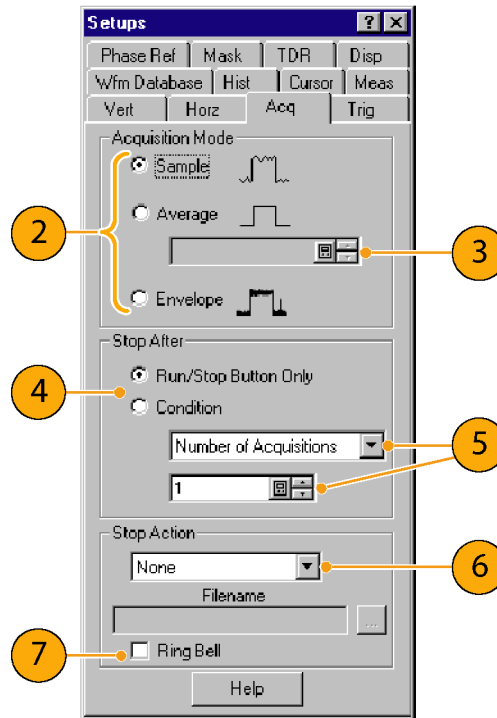

8. Press **RUN/STOP** to start the acquisition.
9. Press **RUN/STOP** again to stop the acquisition.

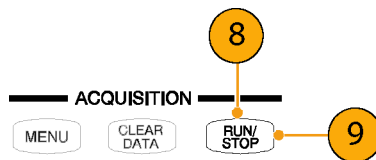

### Quick Tips

- Run/Stop is available on both the front panel and the touch screen.
- If Stop After is set to Condition, pressing RUN/STOP causes only one acquisition to run if the original condition has been met. You need to press CLEAR DATA so that the condition must be met again.

## Setting the Display Style

1. Select **Disp** to start setting the display styles.
2. Choose a display style.

**Normal** selects a display with no acquisition data persistence.

Waveforms are displayed with the new data from ongoing acquisitions replacing data acquired from previous acquisitions.

**Show Vectors** turns on display lines between waveform dots; deselect to display only dots.

Select an Interpolation mode from the pulldown list.

- **Sin(x)/x interpolation** computes record points using a curve fit between the acquired samples.
- **Linear interpolation** computes record points between actual acquired samples by using a straight line fit.

**Variable Persistence** makes data persist for a specified time. New waveform displays accumulate data as new waveform records acquire, but with continuous replacement of the oldest data.

Set a time at which the oldest data is removed.

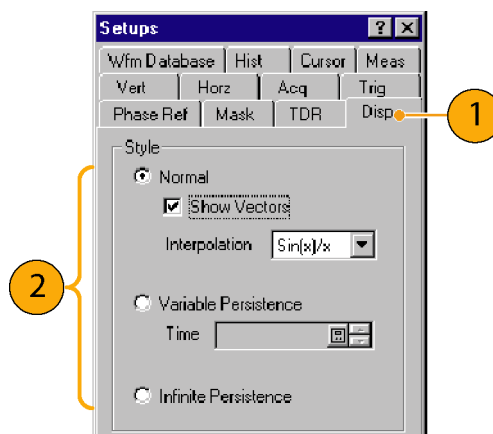

**Infinite Persistence** makes data persist until you change some control or explicitly clear the data. Waveform displays accumulate data as the instrument acquires new data, resulting in a buildup of data in all time slots.

3. Use the Graticule settings to select the graticule style and the graticule color and screen background.

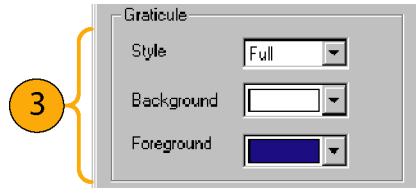

# Triggers

This section contains concepts and procedures for using the trigger system. Detailed information is available in the online help.

## Triggering Concepts

### Trigger Event

When a trigger event occurs, the instrument acquires a sample in the process of building a waveform record. The trigger event establishes the time-zero point in the waveform record and all samples are measured with respect to that event. The trigger event starts waveform acquisition. A trigger event occurs when the trigger source (the signal that the trigger circuit monitors) passes through a specified voltage level in a specified direction (the trigger slope). When a trigger event occurs, the instrument acquires one sample of the input signal. When the next trigger event occurs, the instrument acquires the next sample. This process continues until the entire record is filled with acquired samples. Without a trigger, the instrument does not acquire any samples. This behavior differs from that of real-time acquisition systems, which can acquire a complete waveform record from a single trigger event.

### Trigger Type

This instrument supports edge triggering only, in which edge triggers gate a series of acquisitions. The slope control determines whether the instrument recognizes the trigger point on the rising or the falling edge of a signal. You can set the trigger slope from the toolbar at the top of the display or in the Trigger Setup dialog box. The level control determines where on that edge the trigger point occurs. You can set the trigger level from the front panel with the Trigger LEVEL knob. The slope and level controls apply only when the trigger source is set to External Direct (using the TRIGGER DIRECT INPUT connector).

### Trigger Modes

The trigger modes control the behavior of the instrument when not triggered:

Normal mode sets the instrument to acquire a waveform only when triggered. Normal mode does not acquire data if triggering stops; the last waveform records acquired remains "frozen" on the display (if the channels containing them are displayed). If no last waveform exists, none is displayed.

Auto mode sets the instrument to acquire a waveform even if a trigger event does not occur. Auto mode uses a timer that starts after trigger rearm. If the trigger circuit does not detect a trigger before this timeout (about 100 ms), it auto triggers, forcing enough trigger events to acquire all active channels. In the case of repetitive acquisitions in automatic trigger mode, waveform samples are acquired, but at different places in the data stream (synchronization is lost). If you do not apply a signal to any displayed channel, a baseline is displayed for that channel.

### Trigger Sources

The trigger source provides the signal that the trigger system monitors. The source can be:

- The internal clock of the instrument (TDR clock rate), with user-selectable clock frequencies. The INTERNAL CLOCK OUTPUT connector supplies a replica of the internal clock at the instrument front panel.
- An external signal coupled to one of the trigger input connectors on the front panel.
  - External Direct, DC coupled, and usable with signals up to at least 3.0 GHz

- External Prescale, divided by 16, and usable with signals from 2.0 GHz up to at least 12.5 GHz
- An internal clock-recovery trigger provided by either an optical sampling module that is equipped with a clock-recovery option or a dedicated electrical clock recovery module. Clock recovery is user-selectable for triggering rates that depend on the sampling module used; for example, either 622 Mbps (OC-12/STM-4 standards) or 2.488 Gbps (OC-48/STM-16 standards) for the 80C01-CR Optical Sampling Module.
- A pattern (frame) trigger provided by a PatternSync trigger module such as the 80A06 PatternSync Trigger Module. The output of the pattern sync trigger module must be connected to the EXTERNAL DIRECT TRIGGER INPUT connector on the front panel.

Use a trigger source that is synchronized with the signal you are sampling and displaying. Selection of your trigger source depends on your application, as shown in the following table.

**Table 1: Application-based triggering**

Application	Source to use
Communications (optical) serial NRZ data signals	Set source to Clock Recovery, set the clock-recovery type, and use an optical sampling module equipped with a clock-recovery option supporting the specific data rate of the serial optical signal.  The available clock recovery rates depend on which sampling module is installed.
TDR measurement using an electrical sampling module equipped with TDR	Set source to Internal Clock to use the internal clock of the instrument (TDR clock), and select the appropriate clock frequency. Disconnect any signal connected to the External 10 MHz Reference Input when using the Internal clock.
Measurements on systems with a synchronized pretrigger signal	Set source to External Direct or External Prescaler as appropriate and connect the pretrigger signal.
Any application requiring that the input signal provide the trigger	Set source to External Direct or External Prescaler as appropriate. Use a signal splitter or power divider to couple to both the Ext Direct or Prescaler input and the input channel, so that the sampled signal is also the trigger signal.
Any application requiring that you probe the trigger source	Set source to External Direct and use a Tektronix probe.
Any application requiring that you perform special measurements using gated trigger	Set source to External Direct, select Gated Trigger, and use a TTL connection to trigger gate.

## Trigger Source Connectors

External triggers can be connected to either the TRIGGER DIRECT INPUT or TRIGGER PRESCALE INPUT connectors on the front panel:

- Signals connected to the PRESCALE connector are divided by eight and then fed to the trigger circuits.
- Signals connected to the DIRECT connector are fed directly to the trigger circuitry. The signal is DC coupled and can be up to 3.0 GHz.

When using a given trigger source, disconnect any other trigger source from the front panel to ensure specified performance. Specifically:

- Do not connect a signal to the TRIGGER DIRECT or TRIGGER PRESCALE front-panel connector unless you have selected that input as the trigger source in the Trigger setup dialog box.
- Do not connect a signal to the External 10 MHz Reference front-panel connector unless you have selected that input as the timebase mode in the Horizontal setup dialog box.



## Gated Trigger Connector (Option GT Equipped)

You can attach a BNC cable to the External Gate input at the rear panel (TTL connection) to selectively exclude data from acquisition by means of gating the trigger on and off. Several conditions must be met to get a stable display of waveform data:

- The channel and trigger must be otherwise triggerable without the trigger gate.
- The gating signal must be at a TTL high.
- The triggering system must be enabled.

## Enhanced Triggering

These features can help stabilize triggering and perform special measurements:

- **High Frequency Triggering.** High Frequency triggering increases trigger sensitivity of the trigger circuit by decreasing hysteresis (a transition or noise band), which allows triggering on higher frequency signals.
- **Gated Triggering.** Gated triggering takes the trigger and the External Gate input and applies them to the instrument through what is in effect an AND function. Gated triggering can be used for applications such as simulations of undersea communication fibers where test fixtures are used to repeat the test signal through a short loop of cable to simulate traveling longer distances. The trigger gate can be used to ignore triggers until the signal has traversed the loop many times.

## Trigger Holdoff

Trigger holdoff can help stabilize triggering. When you adjust holdoff, the instrument changes the time it waits before rearming its trigger circuit after acquiring a sample. Before rearming, trigger circuitry cannot recognize when the next trigger conditions are satisfied and cannot generate the next trigger event. When the instrument is triggering on undesired events, you can adjust holdoff to obtain stable triggering.

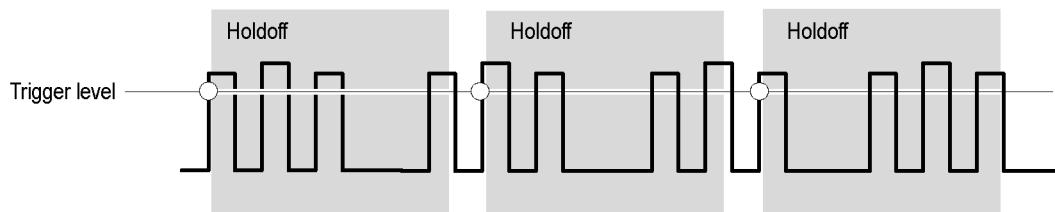

○ Indicates trigger points

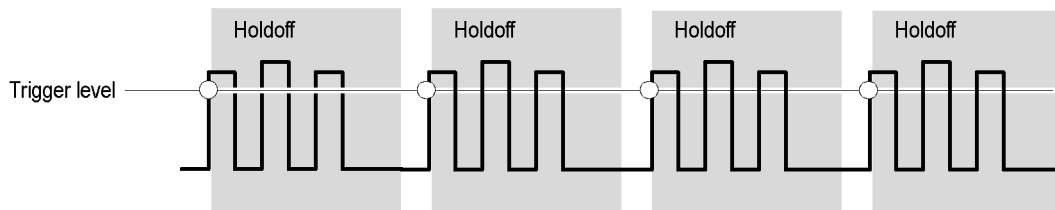

At the longer holdoff time for the top waveform, triggering occurs at valid, but undesired, trigger events. With a shorter holdoff set for the bottom waveform, triggers all occur on the first pulse in the burst, resulting in a stable display.

## Setting Trigger Controls

Nearly all trigger parameters are set in the Trigger Setup dialog window.

1. Press the trigger **MENU** button to display the Trig Setup dialog box.
2. Select a trigger source.
3. Select a trigger mode: **Auto** or **Normal**.
4. Select the trigger slope.
5. Select a trigger level. Click **Set to 50%** to automatically set the trigger level to 50% of the trigger signal amplitude.
6. Set the trigger holdoff value.
7. Select an Enhanced Triggering setting.
8. If the trigger source is set to Pattern Sync, select **Pattern Sync Setup...**. This option is only available with a Pattern Sync module.

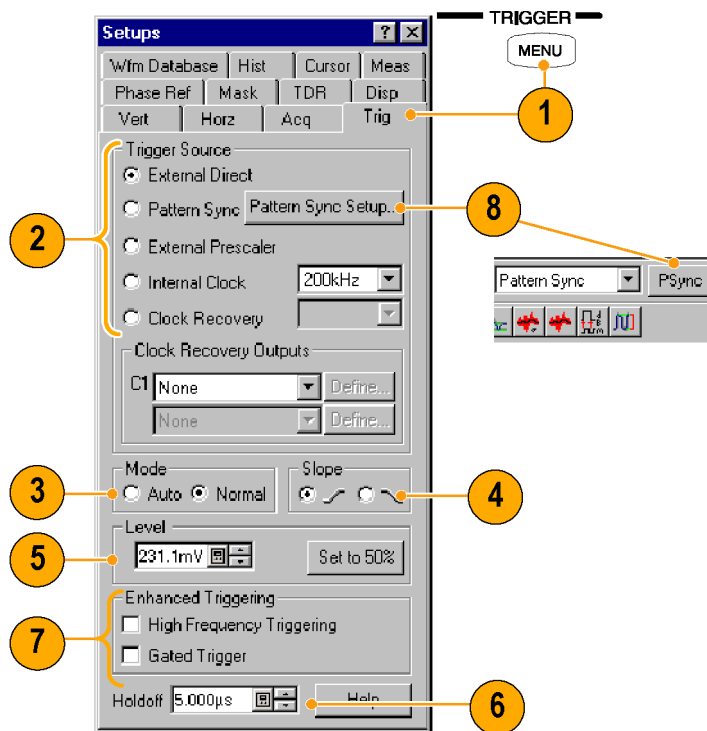

### Quick Tips

- Selecting External Direct as the trigger source requires an appropriate trigger signal be connected to the TRIGGER DIRECT INPUT connector.
- The Slope and Level controls apply only when the trigger source is set to External Direct.
- Selecting External Prescaler as the trigger source requires an appropriate trigger signal be connected to the TRIGGER PRESCALE INPUT connector.
- Selecting External Prescaler sets the trigger Mode to Normal.
- Selecting Internal Clock uses the clock frequency setting in the pulldown list.
- Selecting Clock Recovery requires that a module with clock recovery is available. Select the clock recovery standard from the pulldown lists or user-specified range controls.
- Gated Trigger is only available with Option GT.
- Pattern Sync trigger is only available if a PatternSync module is installed.
- The trigger output from the PatternSync module must be connected to the TRIGGER DIRECT INPUT connector.
- Selecting Pattern Sync as the trigger source presets several trigger controls to predefined settings appropriate for using the external TRIGGER DIRECT INPUT connector.

## Setting Pattern Sync Controls

The Pattern Sync dialog box can be displayed when Pattern Sync is the selected triggering source.

- Select the parameters for the pattern sync module.
  - Select the channel Source where the pattern sync module is installed.
  - Select the Data Rate (bit rate) (default is 2.48832 Gbps).
  - Select the Pattern Length (default is 127).
  - Select a Data:Clock Ratio (data-to-clock ratio) (default is 1:1).
  - Select a Relative Trigger Bit (in the range of 0 to Pattern Length-1) (default is 0).
- Use the AutoSync feature to automatically detect the data rate, pattern length and/or data-to-clock ratio of the applied data and clock signals (data to a sampling module channel and the clock to the Pattern Sync module).
- Enable FrameScan to automatically scan through a pattern (or part of a pattern). The FrameScan control is tied to the FrameScan control in the Horizontal Setup dialog box (changing either one affects the other).

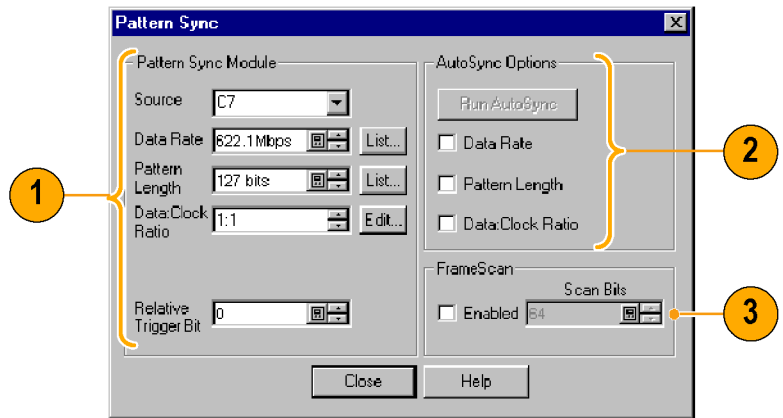

### Quick Tips

- All pattern sync controls are disabled (grayed out) if there are no available pattern sync sources.
- The default selected pattern sync source is the lowest-numbered pattern sync module.
- The Data Rate in the Pattern Sync dialog box is tied to the Bit Rate control in the Horizontal setup dialog box (changing either one affects the other).
- If the entered Data Rate does not match the rate of the selected communication standard in the Horizontal Setup, then the communication standard is changed to "User".
- Using the PatternSync Trigger module in conjunction with FrameScan can improve both acquisition throughput and timing accuracy.
- For highest reliability and speed, it's recommended to manually enter as many control values as possible. The control value must be unchecked in the AutoSync Options to allow manual entry.

## Checking Trigger Status

You can check the status of the trigger from the front panel and in the status bar. The status bar also displays the waveform count.

You can use a phase reference module (such as the 82A04) for triggering. (See page 60, *Phase Reference*.)

1. Check the READY and TRIG'D front-panel controls to determine the trigger status.

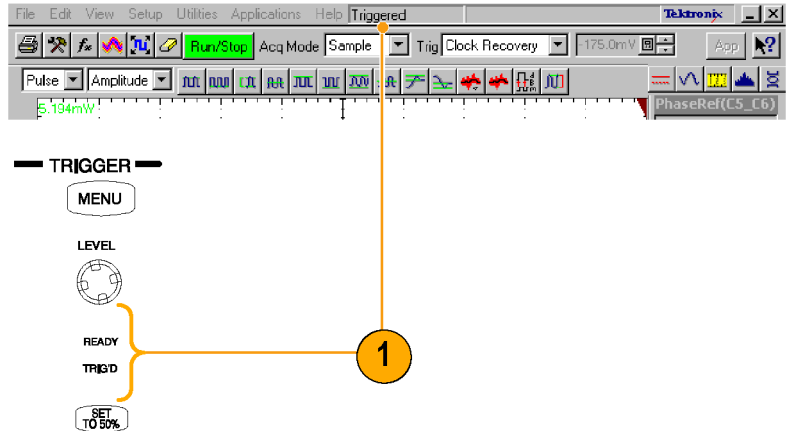

# Analyzing Waveforms

Your instrument features cursors, automatic measurements, statistics, histograms, and math to assist you in analyzing waveforms. This section contains concepts and procedures for analyzing waveforms. Detailed information is available in the online help.

## Taking Automatic Measurements

Automated measurements are divided into signal types: Pulse, NRZ (Non-Return-to-Zero), and RZ (Return-to-Zero). These are further divided into categories: amplitude, time, and area.

1. Use the Vertical buttons to select the waveform to be measured.  
The waveform may be a channel, reference, or math waveform.
2. Select one of the signal (waveform) types and then select a category from the measurement bar.
3. Click the measurement you want in the measurement tool bar.
4. Read the results in the measurements readout.

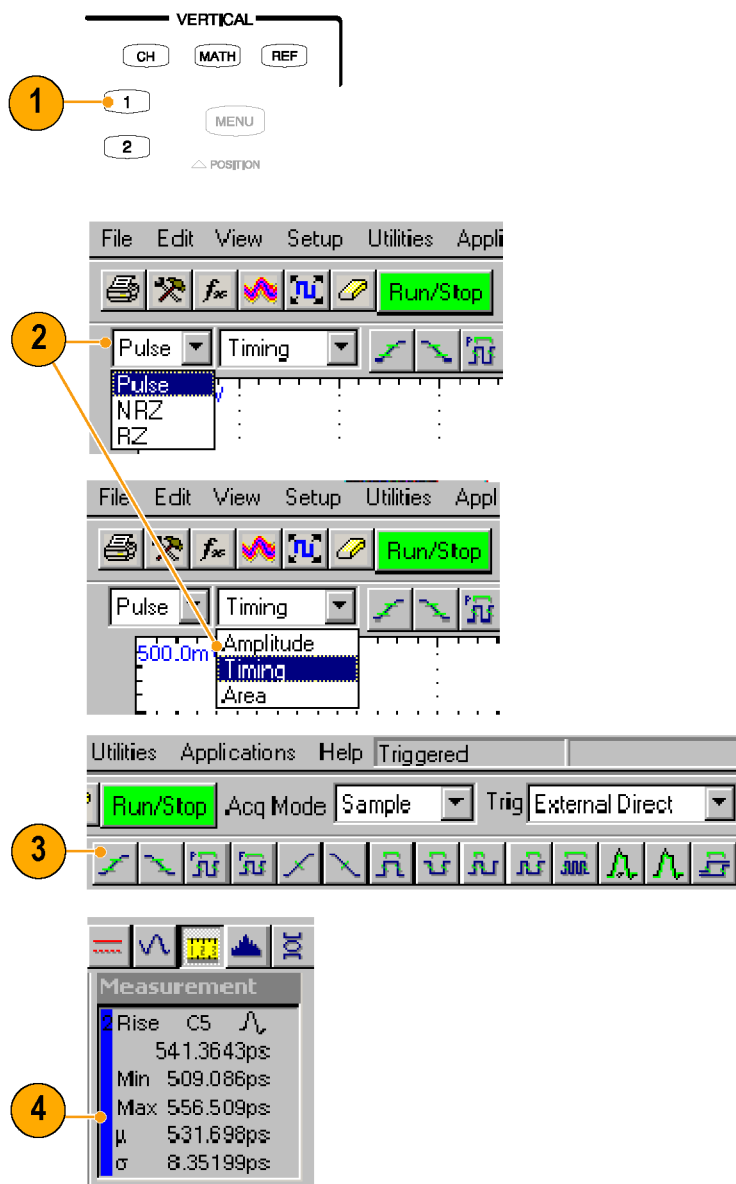

To see statistics:

5. Right click on any measurement readout to display its context menu.
6. Select **Show Statistics** to display measurement statistics in the measurement readout.

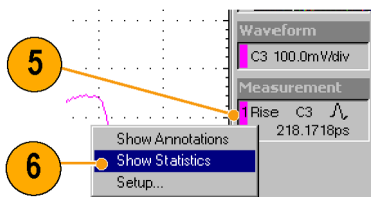

To show annotations:

7. Right click on any measurement readout to display its context menu.
8. Select **Show Annotations** to display annotations that indicate which portion of the waveform is being measured as well as reference levels for the measurement.
9. Note the portion of the waveform being measured.
10. Note the reference levels for the measurement.

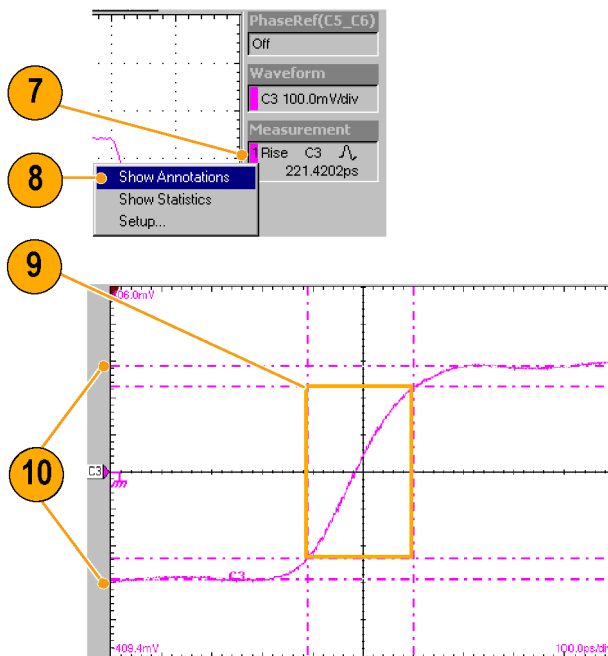

To measure a waveform database:

11. From the application menu bar, select **Setup**, and then select **Meas**.

In the Meas Setup dialog box, make sure the measurement (one of **Meas 1** through **Meas 8**) is selected.

12. In the Source tab, check the **Use Wfm Database** option.

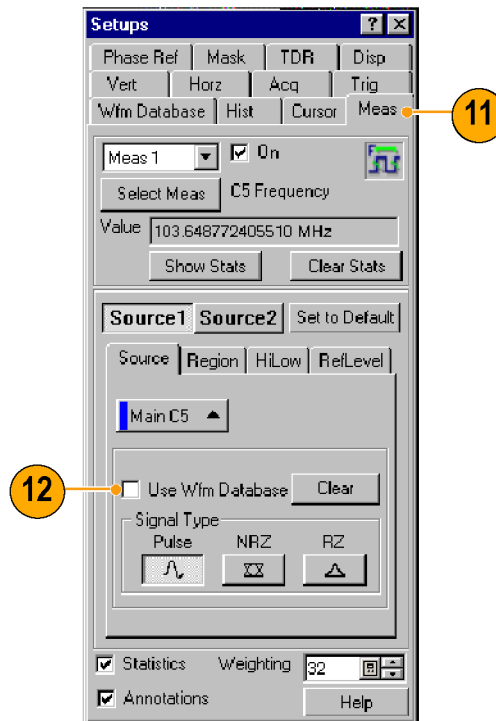

To localize a measurement:

13. Select **Meas**.
14. Select the **Region** tab.
15. Click the **On** box to turn gating on and to display the gates on screen.
16. Use the **G1** (Gate1) and **G2** spin controls to adjust the gates on screen such that the area to measure is between the gates.
17. Click the **Annotations** box to display which portion of the waveform is being measured and the reference levels for that measurement.

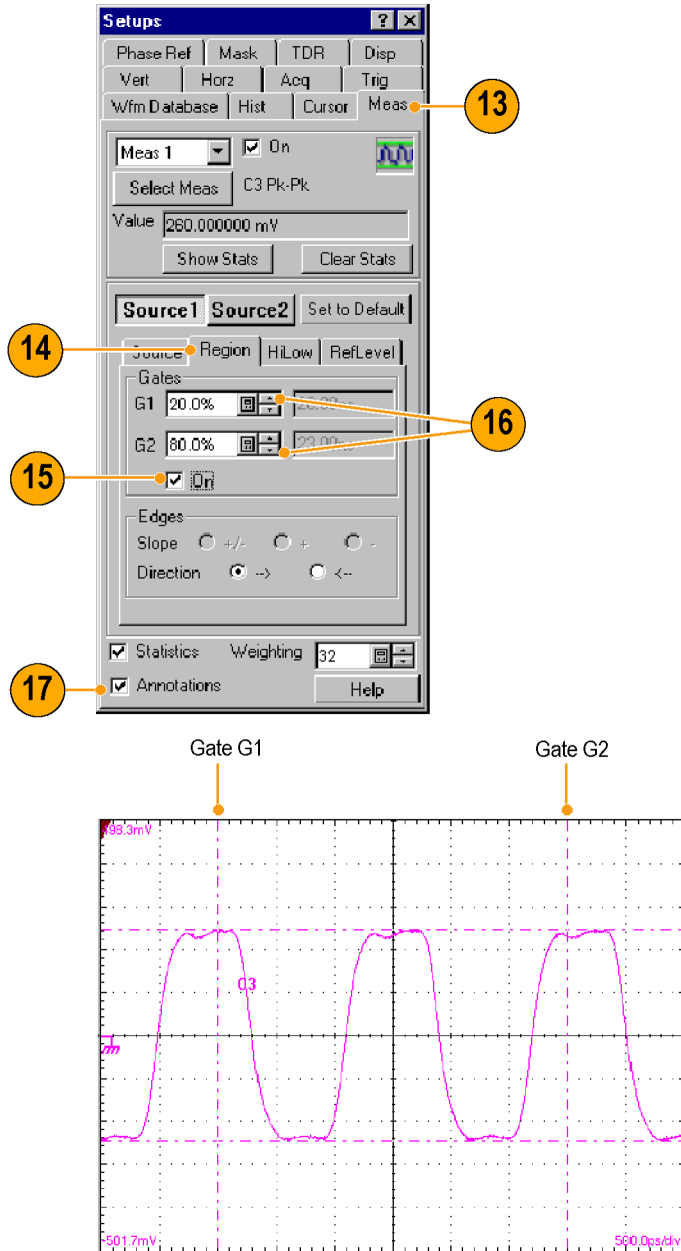

### Quick Tips

- If, at the time you first create a measurement, the measurement source you select is displayed as a waveform database, the database will automatically be measured. Deselect the **User Wfm Database** option if you want to measure the vector waveform instead of the database.
- Gate values are entered as a percentage of the waveform, displayed from left to right. If no keyboard is installed, access the virtual keyboard and use the touch screen to enter values.
- You can select and drag the gates to new locations by using a mouse or the touch screen.



## Turning Off Automatic Measurements

Up to eight automatic measurements can be assigned. Once all eight slots are used, no more can be assigned. If you need to take another automatic measurement, and all measurement slots are used, make a slot available for the new measurement or redefine a current measurement slot.

1. Note the assigned measurements. In this example, measurement slots 1 and 3 have measurements assigned.
2. Select **Meas** (measurement) from the Setup dialog box.

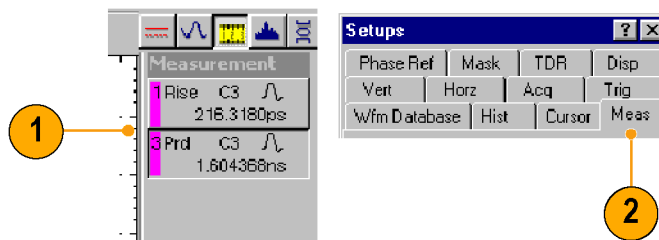

3. Use the pulldown list to select **Meas 3** (measurement slot 3).
4. Note that measurement slot 3 has a measurement assigned and is displayed (On).

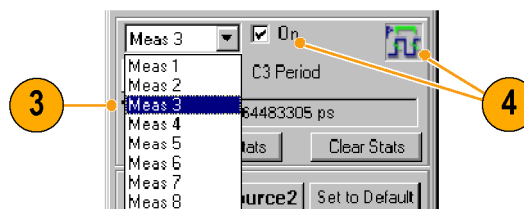

5. Press the **Select Meas** button to set measurement slot 3 to **None**.

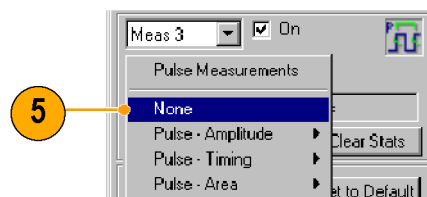

6. Note that measurement slot 3 is Not Defined and no measurement icon is displayed.



7. Note that measurement slot 1 has a measurement assigned. It is set to not display, but the measurement slot is still used.



### Quick Tip

- To easily redefine a measurement slot, select **Select Meas** and choose a new measurement.

## Cursor Measurements

Use cursors to measure amplitude and time quickly and with more accuracy than when using the graticule to take measurements. Because you position cursors wherever you want on the waveform, they are easier to localize to a waveform segment or feature than automatic measurements.

1. Press the **CURSORS** button:

- Once for Vertical Bars
- Twice for Horizontal Bars
- Three times for waveform cursors

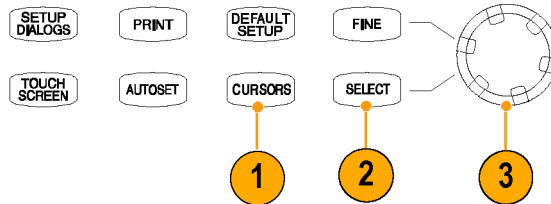

2. Press the **SELECT** button to toggle selection between the two cursors. The active cursor is represented by a solid line.
3. Turn the General Purpose knob to position each cursor on the waveform to measure the feature that interests you.

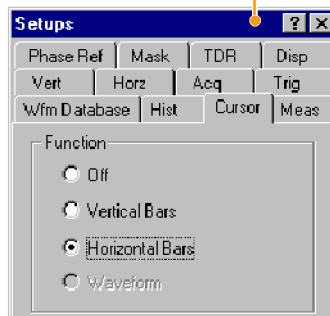

4. Vertical bars (V Bars) measure time (horizontal) parameters.

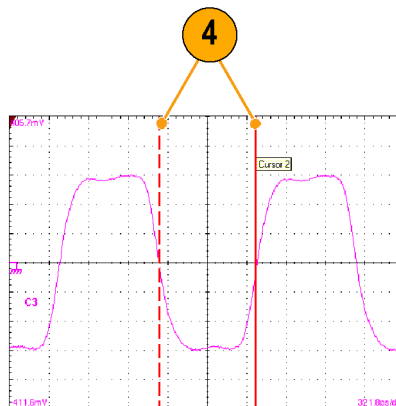

5. Horizontal bars (H Bars) measure amplitude parameters.

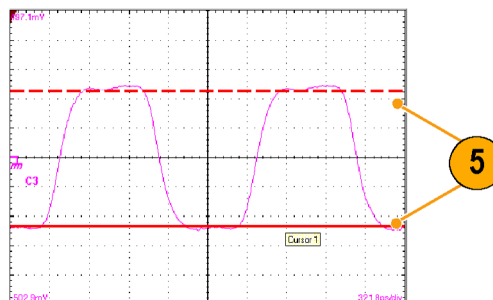

6. Waveform cursors measure vertical and horizontal parameters simultaneously. Waveform cursors are attached to the waveform and track with the waveform points.

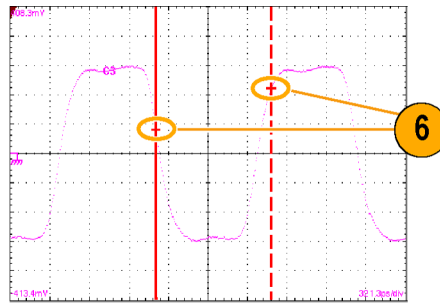

7. Read cursor measurement results on the display.
8. Click this button to toggle the cursor readouts on and off.

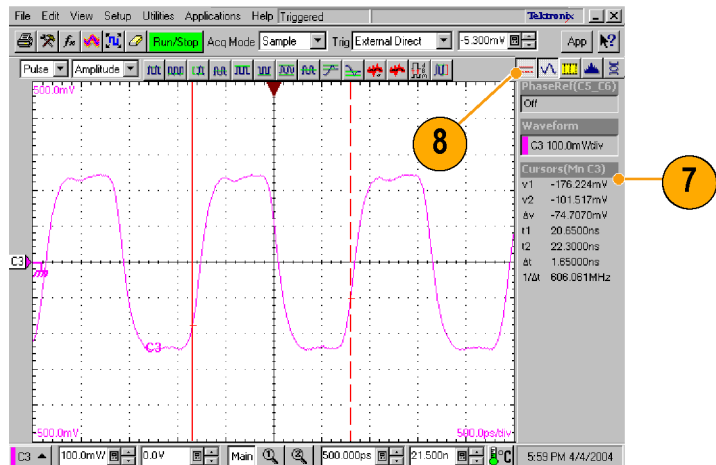

### Quick Tips

- Cursors require that at least one waveform is selected on the screen.
- Waveform cursors are not available if a waveform database is selected.
- You can drag a cursor to place it relative to the waveform.
- You can assign each cursor to a different waveform to measure differences between waveforms. Make these selections in the Cursor setup dialog box.
- If you use two magnified time base views, you can take precision timing measurements between two distant points on a waveform. Magnify each point of interest in a separate time base, and then place one cursor on each point. The  $\Delta$ -time cursor readout will then reflect the position and resolution of the magnified time bases.

## Math Waveforms

You create math waveforms by creating a math expression using the Define Math dialog box. In that dialog box, you apply numerical constants, math operators, and functions to operands, which can be channels, waveforms, reference waveforms, measurements (scalars), or fixed scalars. You can display and manipulate these derived math waveforms much like you can the channel and reference waveforms.

1. Press the Vertical **MATH** button (once or twice if needed) to display the Define Math dialog box.
2. Click the **Math Waveform** drop-down list in the dialog box and select one of the eight available math waveforms.
3. Use the dialog box to define a math expression. Some guidelines for creating your expression follow:
  - Sources (C1 - C8, R1 - R8, and Meas 1 - Meas 8) should be set up before you use them (references and automated measurement scalars should be defined).
  - Elements that appear grayed out cannot be selected because they would result in an illegal entry.

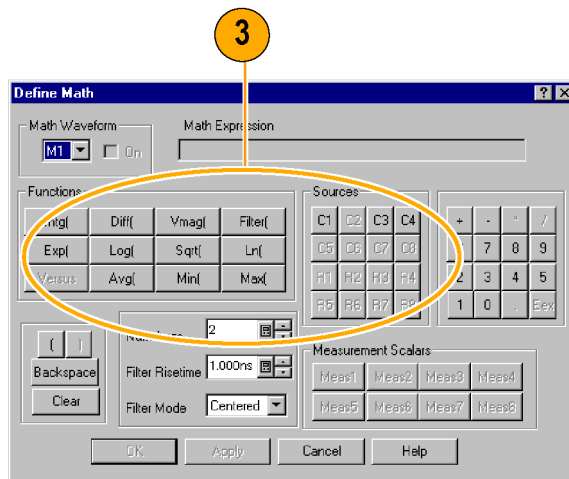
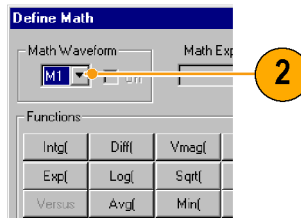
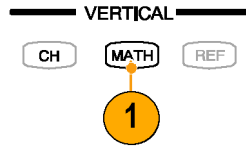

- Use the filter controls in the dialog box to apply a filter to the math waveform defined by the expression.

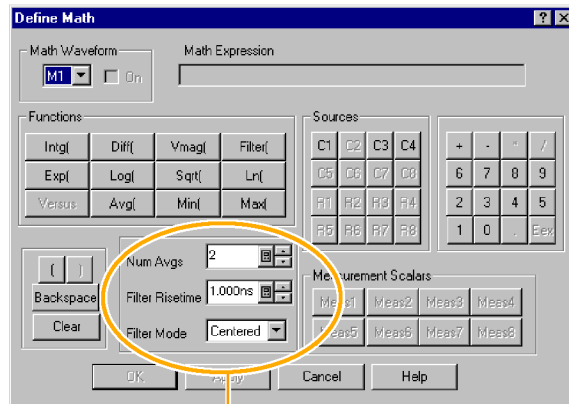

- When you have defined the expression, click **Apply**.
- Select the **Math Waveform On** box, so that the waveform displays.

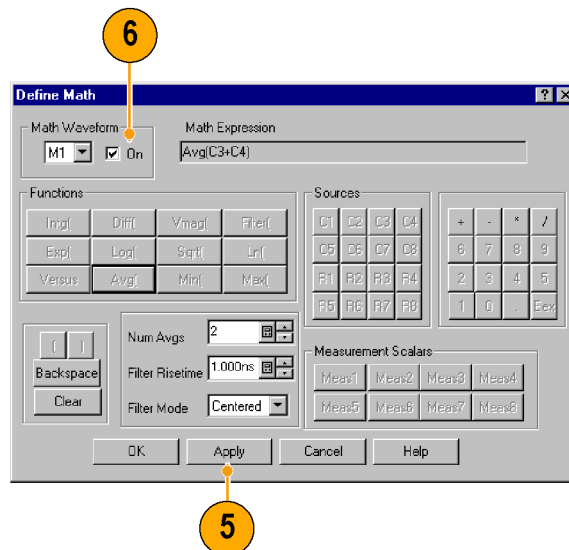

### Quick Tip

- If you select a waveform that is already defined, its math expression appears in the dialog box. To use the waveform, click the Clear button, which discards its previous math expression.

## Waveform Databases

The four available waveform databases can be used for measurements, histogram calculations, mask testing, and generating a density-style, graded display. Waveform databases may be automatically allocated for measurements, histograms, and mask testing.

1. Click **Wfm Database** in the Setup dialog box.
2. From the pulldown menu under Database, select one of the four available databases.
3. Click the **Source** button to select the waveform source.
4. Click **On** to start accumulating data from the selected source.
5. Click **Display** to turn on the display of the waveform database.
6. Select the Persistence mode for the selected waveform.
7. If you selected Variable persistence, you can specify the number of waveforms that are included in the waveform database.

The following Display Options affect all waveform databases that you display:

8. Click a grading display option.
9. Click **Invert** to emphasize the least occurring pixels by reversing the intensity/color assignments to each grading partition.
10. Select one of the four grading methods.
11. If you selected one of the two Emphasized grading methods, slide the Emphasize Counts percentage control to specify the range of counts you want emphasized.

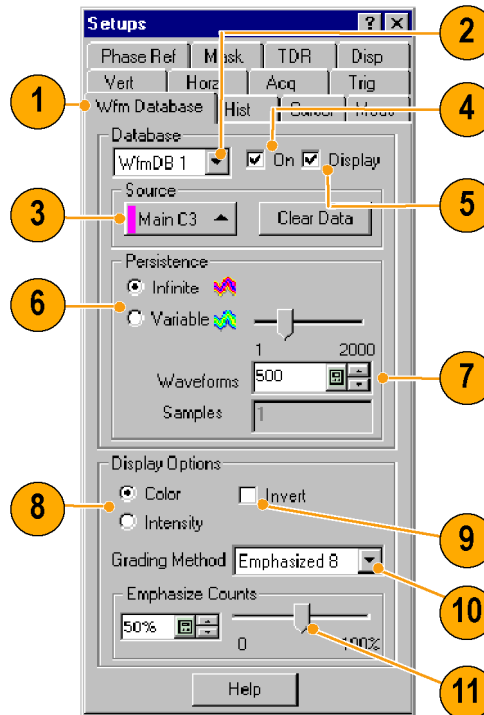

### Quick Tip

- Certain measurements require the use of a waveform database and automatically set the measurement system to use a waveform database if available.

## Display a Communication Signal

1. Carefully install the sampling module in the instrument. (See page 6, *Installing Modules*.) Also, read the user manual for your specific module.
2. Connect signals to your sampling module.



**CAUTION.** Always observe static-safe procedures and cautions as outlined in your sampling-module user manual when connecting signals.

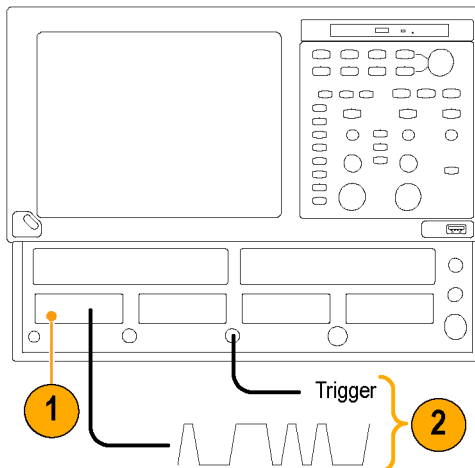

3. Select the channel that you want to display in the Mask setup dialog box.
4. Select the communication standard.
5. Click **Autoset** in the Mask setup dialog box or on the front panel.

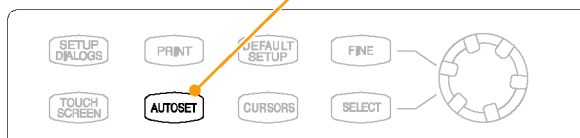
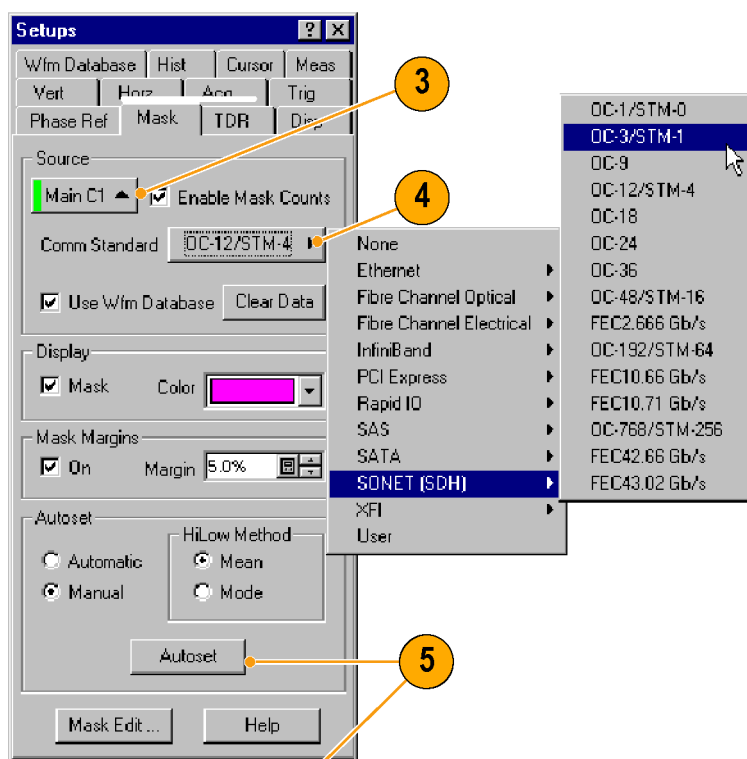

## Display and Analyze Communication Signals Using Mask Testing

Use mask testing to test your waveforms for time or amplitude violations against a predefined industry standard or a user-defined mask. Mask testing counts waveform samples (called hits or violations) that occur within a specific area (the mask). Use the communications-standard masks that this instrument provides (SONET/SDH, Fiber Channel Optical and Electrical, and Ethernet) to test your signals, or define your own masks.

1. Select the waveform to be mask tested from the drop-down list under Source.

2. Select a standard mask in the Mask setup dialog box. Selecting a communication standard or user-defined mask automatically:

- Displays the mask on screen and autosets for the mask if Automatic is checked in the dialog box.
- Enables mask testing.
- Displays mask count statistics in the mask readout. A mask does not have to be displayed to have mask counting enabled.

3. If you want, disable mask counts. (Selecting a mask in step 2 automatically enabled them.)

4. Check **Use Wfm Database** to use a waveform database as the waveform source.

5. You can enable margins to explore design margins of your communications signal.

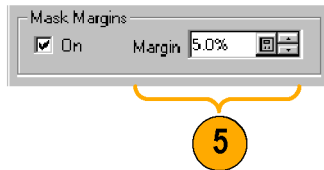
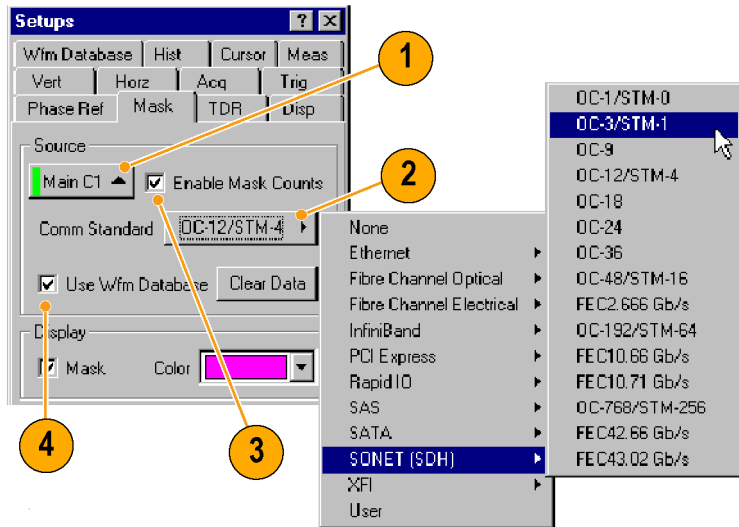



To autoset the waveform to mask:

6. Click the Autoset button to perform a manual autoset on the mask-source waveform.
7. Select the HiLow Method used to determine the High and Low values when aligning the input signal to the masks.  
 Mean sets the Mask Autoset to use the mean value of the High level (topline) and Low level (baseline), taken within the fixed eye aperture (center 20% of the eye), to align the input signal to the NRZ mask.  
 Mode sets the Mask Autoset to use the High level (topline) and Low level (baseline), taken across one unit interval of the eye diagram, to align the input signal to the NRZ mask.

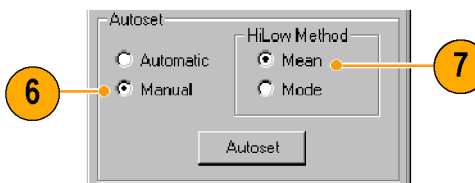

To set a Stop Action:

8. Click **Acq** in the Setup menu.
9. In the Acq Setup dialog box, check the **Condition** option under **Stop After**.
10. In the Condition pulldown list, select a mask-related criteria, such as **Mask Total Hits** and set a count, such as 1, in the count box.  
 These settings stop acquisition when mask violations satisfy the criteria you set.

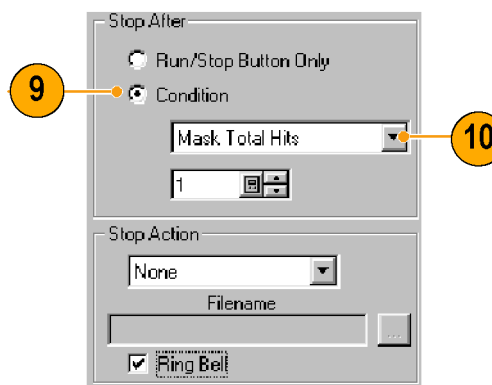
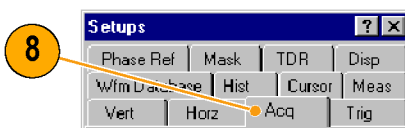

11. Push the **RUN/STOP** button to restart acquisition, if stopped.

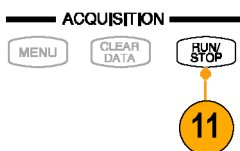

To restart testing:

12. To restart after a Stop After condition occurs, push the front-panel **CLEAR DATA** button.

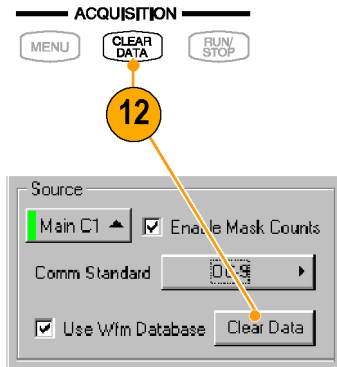

13. Read the mask-hits count in the readout.

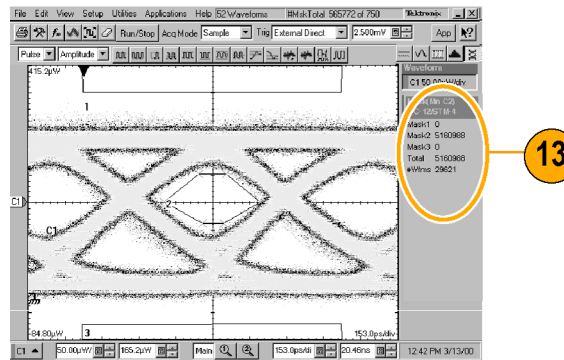

### Quick Tips

- Selecting a source that is currently displayed as a waveform database automatically enables mask testing on the database. To mask test the waveform instead of its database, deselect the **Use Wfm Database** box.
- You can choose to autoselect the mask-source waveform to the mask each time you select a new mask standard by checking **Automatic** under Autoselect.
- Pressing the **RUN/STOP** button after acquisition has stopped due to a Stop After condition being met causes the instrument to acquire one (and only one) additional waveform.
- The **Clear Data** button resets all mask counts. In addition, if the source for mask testing is a waveform database, clicking this button clears the waveform database.

## FrameScan

Use FrameScan to test a specific bit (or range of bits) in a repeating frame of data. FrameScan acquisitions allow detailed display and analysis of individual, complete waveforms or of the bit sequences leading up to a failure. This ability to identify the specific patterns that caused the failure makes the FrameScan mode superior to traditional methods.

1. Select the Horizontal Setup menu.
2. Click **Enabled** in FrameScan.
3. Click **Auto Position**.
4. Set the **Start Bit** to specify the starting bit location for the scan when FrameScan Auto Position mode is on.
5. Set the **Scan Bits** to the number of bits or subframes you want to acquire.

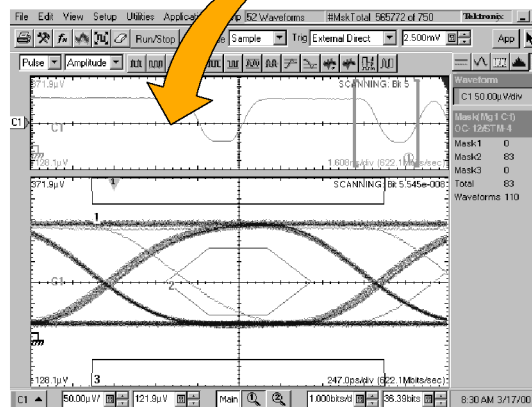
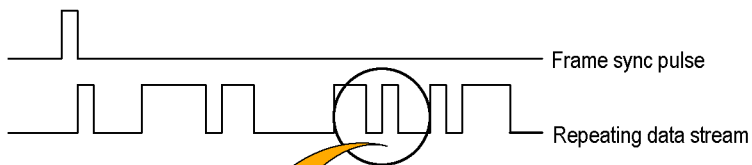
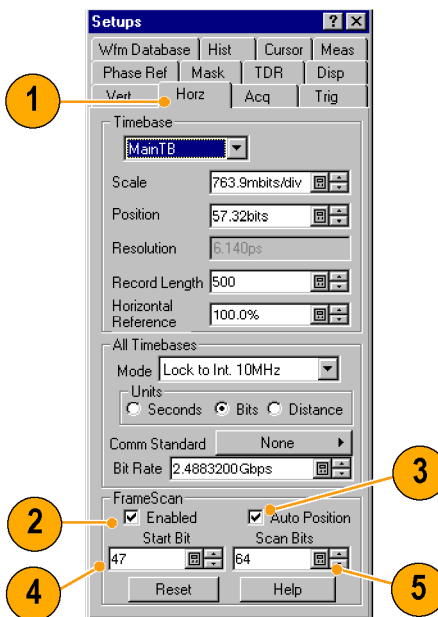

### Quick Tips

- The Start Bit control determines the starting horizontal position that FrameScan uses for each acquisition scanning cycle. The Auto Position control must be on to use the Start Bit.

- The Auto Position control is disabled when the Trigger Source is set to Pattern Sync. When using Pattern Sync, use the Relative Trigger Bit control in the Pattern Sync configuration settings.

## To Use TDR

To take TDR measurements, you must have a TDR-capable sampling module installed and your network must be attached to the TDR sampling module.

1. Select TDR from the Setup menu.
2. Click the **channel** button to automatically display the incident and reflected steps by automating the following tasks:
  - Turns on the channel.
  - Turns on a step.
  - Sets trigger source to Internal Clock.
  - Sets acquisition to Averaging.
  - Changes display style to Show Vectors.
3. Select a channel pair to perform a differential TDR measurement. Press **Diff** to automatically set up the differential measurement for the channel pair.
 

All the tasks listed in step 2 are performed for both channels and the pulse polarity of the second channel is set to negative.
4. Click the polarity button to toggle the step edge.
5. Set the vertical scale Units to V (volts),  $\Omega$  (ohms), or  $\rho$  (rho).
6. If performing differential TDR, select the channel (TDR module with dual channel adjustment) or the even-numbered channel of the channel pair (TDR module with single channel adjustment) for deskew adjustment.
7. Set the Deskew percent value.

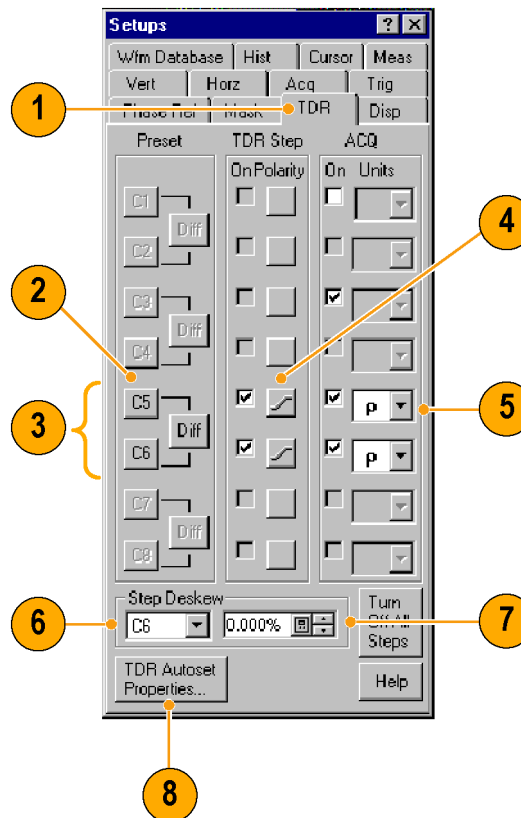

8. Press **TDR Autosest Properties** to display the Autosest Properties dialog box to prepare the TDR autosest.

### Quick Tips

- Use a lower internal clock rate to examine long cables.
- For a TDR module with single channel deskew capability, only the even-numbered channel of the module is selectable for deskew. For a TDR module with dual channel deskew capability, both channels of the module are selectable for deskew. (See page 72, *Skew and Deskewing*.)

## Phase Reference

Use the Phase Reference module, and the phase-correction timebase that it supports, when you need to acquire with ultra low jitter. Using this mode reduces trigger jitter in the instrument which lets you measure clock and other phase jitter vulnerable signals with more fidelity.

To use phase reference, you must have a Phase Reference module (such as the 82A04) and a phase reference clock signal synchronous to the data to be acquired connected to the Phase Reference module. Refer to the online help for more information on using the Phase Reference timebase.

1. Click Phase Ref in the Setup menu to display the Phase Reference dialog box.

2. Turn Phase Correction on by checking either **Free Run** or **Triggered**.

- Free Run: A trigger is automatically generated. Multi-clock-cycle-period displayed signals are synchronous with the phase reference but overlaid.
- Triggered: Samples are corrected for horizontal position per the phase reference supplied, but otherwise have all the attributes of a triggered waveform.
- Triggered (SSC): Phase correction is active and the trigger is used to determine the horizontal acquisition window. The instrument assumes some amount of Spread Spectrum Clocking contained on the phase reference input clock.

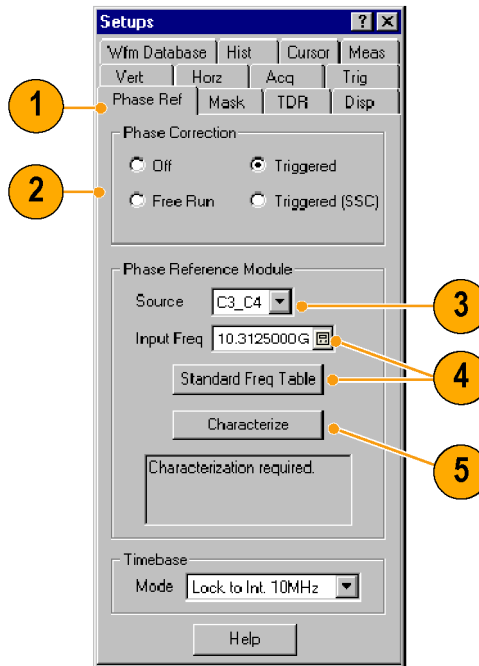

3. Click the **Source** control to select the module to which you connected the clock (if more than one phase reference module is installed).

4. Select the input frequency to the phase reference module.

- Use the Input Freq control to enter the frequency of Phase Reference clock or use the **Standard Freq Table** button to select a communications standard.

5. Press the Characterize button to characterize the clock signal attached to the phase reference module.

### Quick Tips

- When entering the phase reference clock frequency, the value must be within 1% of the actual frequency.
- The instrument accommodates up to approximately 5000 ppm of SSC.

## Histograms

The instrument can display histograms constructed of waveform data. You can display both vertical (amplitude) and horizontal (time or distance) histograms, but only one at a time.

1. Display the Hist (Histogram) dialog box.
2. Check the **Enable Histogram** box.
3. Click the **Source** button to select the waveform source.
4. Select a vertical or horizontal histogram.

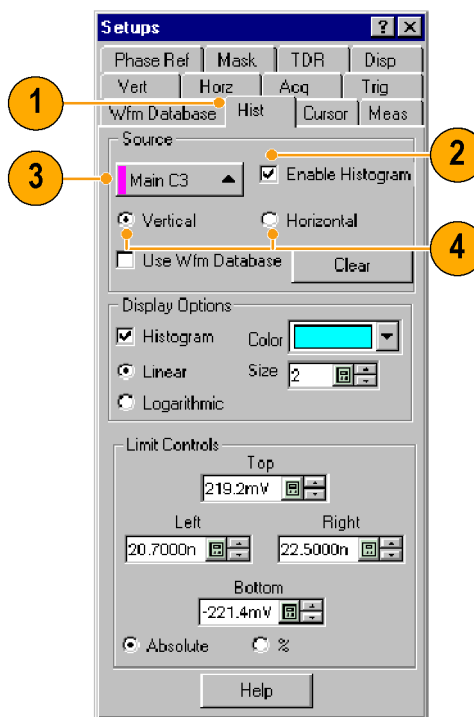

5. Click and drag the edges of the histogram box to enclose a portion of the waveform.
6. The histogram displays at the edge of the graticule. The histogram statistics are displayed in the readout.

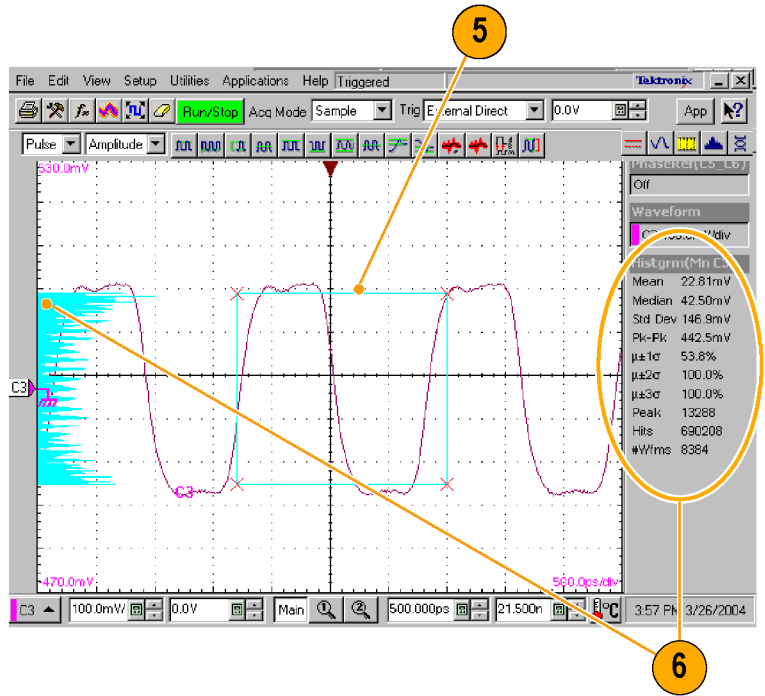



## Document Your Results

This instrument can save any number of waveforms, limited only by the space you have to store them. By saving a waveform, you can recall it at a later time for comparison, evaluation, and documentation. This capability is helpful when you want to:

- Recall a waveform for further evaluation or comparison with other waveforms.
- Extend the waveform-carrying capacity of the instrument. The instrument supports eight reference, eight channel, and eight math waveforms. If you want more than eight reference waveforms, you can save the additional reference waveforms to disk for recall later.

1. To Save a setup or a waveform, click **Save Setup** or **Save Waveform** in the File menu.

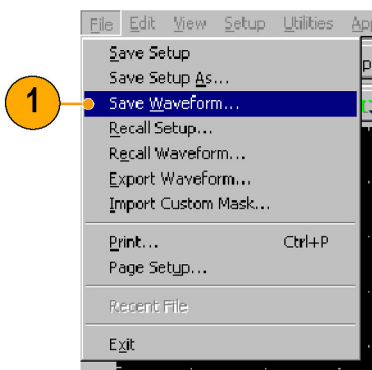

2. To export waveform data, click **Export Waveform** in the File menu.

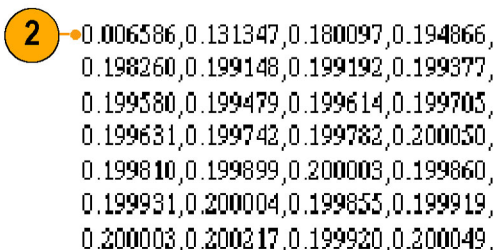

3. To print a hard copy to an attached printer or a network printer, click the print icon in the toolbar.



4. To copy a screen image into another application, choose the **Print to file** option in the print dialog box. Save the screen image in a format that is compatible with your application, and then insert the screen image into your document.

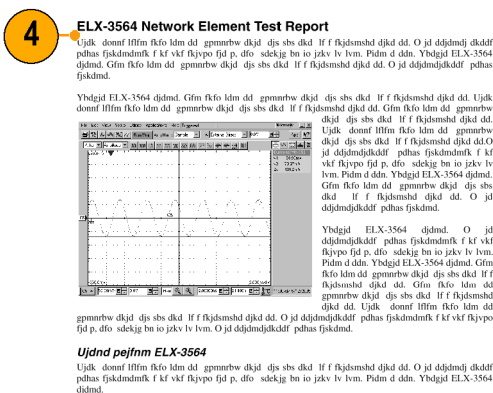



## Using the 80A05 Electrical Clock Recovery Module Examples

This section contains various ways to use an 80A05 Electrical Clock Recovery module with other optical and electrical sampling modules.

The 80A05 brings ease of use to sampling oscilloscopes by offering simple triggering on both single-ended and differential electrical signals through its clock recovery. The differential functionality, in particular, simplifies acquisitions that are otherwise difficult to accomplish. The 80A05 can recover clock signals at most standard rates between 50 Mb/s and 12.6 Gb/s.

The skew between signals presents a challenge to many measurements. Verifying the amount of skew and deskewing when necessary keeps your skew errors in check and limits the undesirable influence of common-mode signals on your measurements.

This section presents example setups and information about vertical calibration, horizontal deskew, and minimizing the effects of skew on your measurements. Each example includes an illustration of the setup.

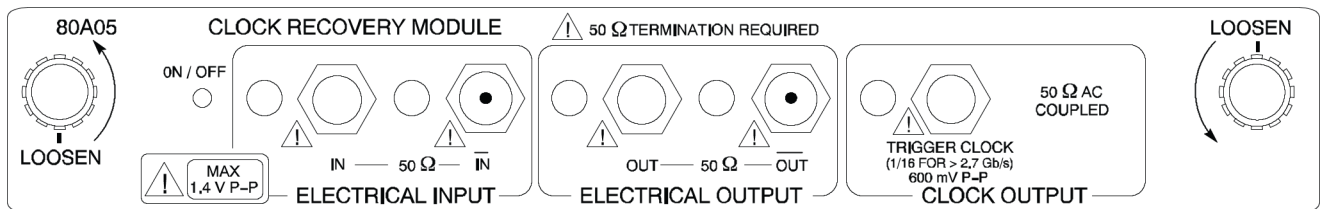

Figure 1: 80A05 module

## Clock Recovery / Trigger on Recovered Clock

In this example, the signal is connected to the 80A05 module. The mainframe is set to trigger when the module delivers a recovered clock signal. The connections for acquired signal(s) are not shown in the illustration.

1. Set your mainframe trigger source to Clock Recovery for the channel that the 80A05 occupies.
2. Attach the input signal cables to the 80A05 module inputs and terminate the signal outputs in 50  $\Omega$ .
3. The 80A05 can then deliver a recovered clock signal to the mainframe to be used for triggering.

---

**NOTE.** This differential setup may require deskewing before measuring signals from your device under test (DUT). (See page 72, Skew and Deskewing.)

---

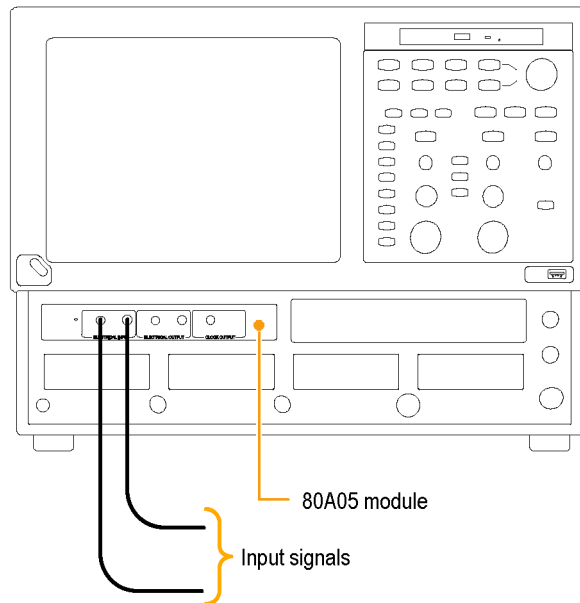

## Clock Recovery / Trigger for Optical Signal, with the 80C12 Optical Module

In this example, the 80A05 delivers the recovered clock signal from the 80C12 to the mainframe to be used for triggering.

1. Set your mainframe trigger source to Clock Recovery for the channel the 80A05 occupies.
2. Connect the ELECTRICAL SIGNAL OUT from the 80C12 module to the ELECTRICAL SIGNAL IN of the 80A05 using an electrical signal cable.
3. Attach the optical input signal cable to the 80C12 and terminate the 80A05 signal outputs in 50  $\Omega$ .  
The 80A05 will deliver the recovered clock signal from the 80C12 to the mainframe.

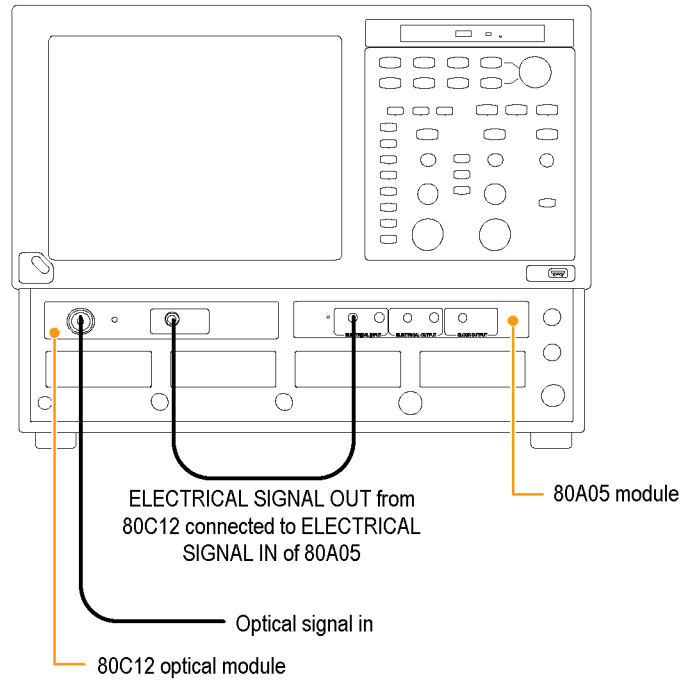

## Differential Clock Recovery and Acquisition

In this example, the electrical output signals of the 80A05 module are connected to an electrical sampling module(s), such as an 80E03, with a matched set of differential cables.

1. Connect the 80A05 outputs to the 80E03 inputs using a matched set of coaxial cables.
2. Connect the output of the DUT to the 80A05 inputs using another set of matched coaxial cables.

This differential setup may require deskewing before measuring signals from your device under test (DUT). (See page 72, *Skew and Deskewing*.)

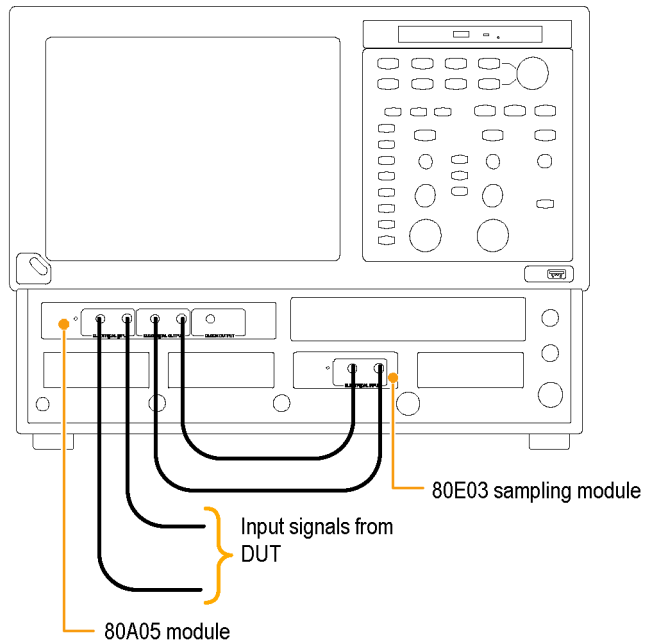

## Probing with Low-Impedance Probes

Low-impedance probes (also called Z0 probes or controlled-impedance probes) are passive probes that have very low input capacitance and low input resistance. These probes are a useful choice for some applications. However, because the input resistance on these probes is low, they can cause measurement errors.

Passive probes, such as the P6150 Probe (with 10X probe tip) and the P8018 Handheld TDR Probe, when used with good quality cables, can typically probe systems approaching 20 GHz. In particular, the bandwidth of the P6150 Probe is greatly improved by using a very short, high speed cable.

When debugging or characterizing a functioning circuit, a controlled-impedance probe will drain current from the DUT. When the in-circuit source impedance is not small compared to the probe impedance (typically 500  $\Omega$  for 10X), this current can be appreciable and impact important parameters such as bias point, offset voltage, noise margin, signal amplitude, and switching point. In this case, the probe introduces errors in the measurements it is being used to take. The probe can change circuit behavior or even cause the circuit to stop working.

When using differential probes, you should use a matched set of coaxial cables.

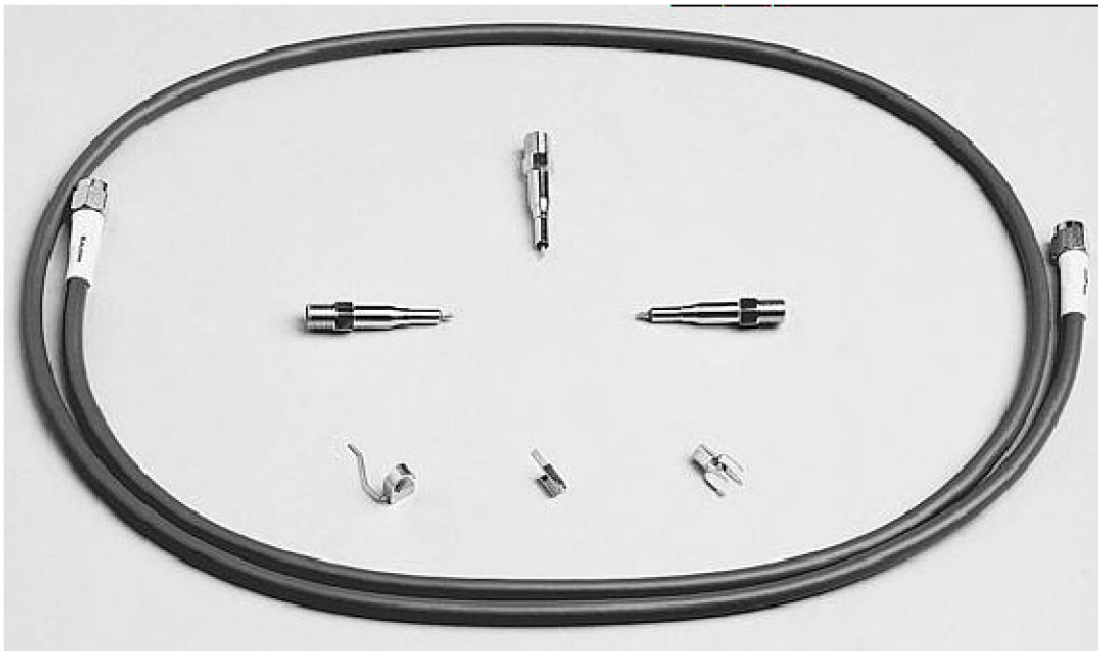

Figure 2: P6150 Probe

## Probing with Differential to Single-Ended Probes

The popular P7380 series TekConnect probes can be used with 80A03 TekConnect adaptor. The P7380 offers two outputs: one on the TekConnect connector, and another on an SMA on the probe body. If the signal captured by the probe is to be used for both clock recovery and acquisition, we recommend using the signal from the SMA on the probe body for the clock recovery task. Connect the probe body SMA to the 80A05 input. The acquisition path uses the TekConnect signal.

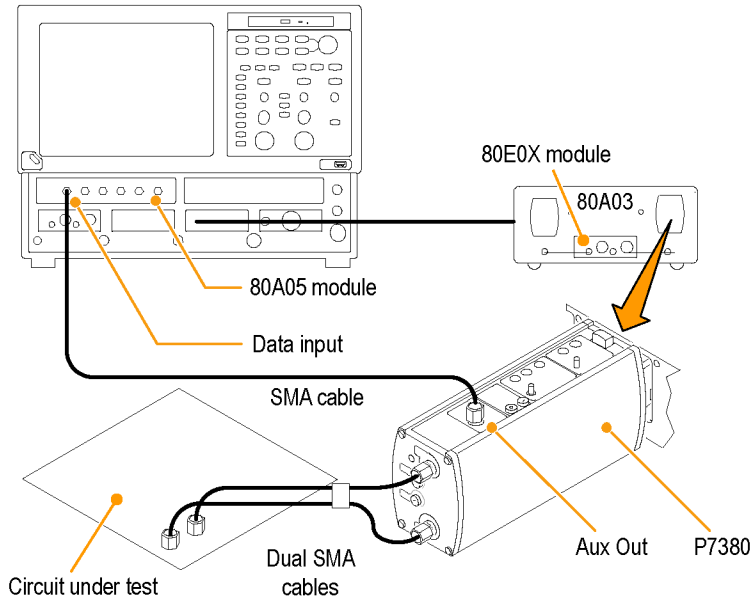

Figure 3: Differential to single-ended probes setup example



## Vertical Gain Adjustment

If the signal is passing through the Input of the 80A05 module, it might be necessary to adjust the signal for accurate Vertical Scale. The built-in calibration voltage attribute of the DSA8200 mainframe makes this a simple procedure. After connecting your signal source or sources, do the following steps. If you have a differential setup, repeat these steps for both inputs.

1. Select the **Setup > Vert** menu.
2. Set DC Cal voltage to an appropriate value.
3. Use the External Attenuation window to adjust the value to achieve the proper voltage reading (as measured with a Pulse Mean Measurement).

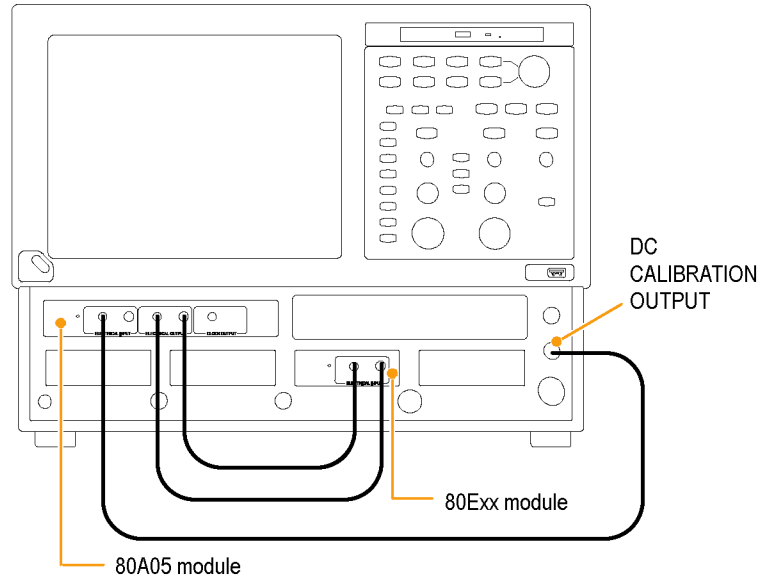

---

**NOTE.** The output impedance of the DC CALIBRATION OUTPUT is close to  $0 \Omega$ .

---



---

**NOTE.** This procedure applies equally well if a probe is connected to the input of the 80A05 module. For example, both the P6150 and the P6380 probes can be calibrated using this DC CAL voltage.

---

# Skew and Deskewing

The propagation delay inherent in connecting cables and probes can result in inaccurate amplitude and time-correlated measurements. This is caused by the difference between two or more delays, known as skew. Skew can be present in multi-channel applications, and is of particular concern in differential systems. To obtain the best measurement and analysis results from your instrument, you will need to remove skew, a process known as deskewing.

In differential (non-TDR) applications, skew can occur in acquired signals as they propagate from their source to the mainframe. In TDR applications, skew can occur in signals that propagate from the instrument to the device or system under test (DUT), specifically the TDR stimulus pulses, as well as from acquired signals.

The following procedures and examples explain how to minimize and measure skew in non-TDR and TDR systems.

## Quick Tips

- Minimize skew by using balanced cable pairs.
- Measure and match your cables. TDR modules such as 80E10, 80E08, and 80E04 allow you to measure cable delays with very high precision.
- In differential systems, use differential probes or differential SMA to single-ended active convertors, such as the Tektronix P7380SMA.

## Methods to Adjust Skew

### Using a Phase Adjuster

Skew can be adjusted with the use of a variable delay line (phase adjuster). Tektronix part number 015-0708-00 is a phase adjuster with a 25 ps range and VSWR of 1.3:1 at 18 GHz. The advantage of a phase adjuster is that it is functionally invisible. The disadvantage is that signal fidelity is slightly impacted.

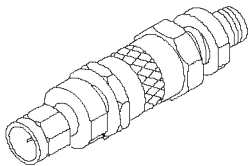

### Channel Deskew and Channel Delay

To ensure that random, differential, or common-mode signals can be properly time aligned, the DSA8200 allows the skew to be adjusted between individual modules by way of independent acquisition timebases (not available in phase reference mode). This is referred to as channel deskew. In addition, some modules (the 80E06, 80E07, 80E08, 80E09, and 80E10) contain an additional, and highly useful, skew adjustment capability called channel delay.

While both deskew and delay allow you to compensate individual channels for skew differences introduced externally from the instrument, they are implemented differently. Deskew is applied to the strobe drive of the module that is common to both channels in the module. When the deskew values differ between the channels, the instrument automatically performs separate acquisitions for each channel (on different sets of triggers) in order to satisfy the requested deskew difference. Delay is applied only to an individual channel in the module. Therefore, to retain maximum performance, keep the deskew values for both channels in a single sampling module the same and use the delay control if possible.

Channel deskew can be used for repetitive signals. Data is captured with the timebase skew adjusted for each channel, one at a time. This method of skew adjustment relies on the fact that your signals are completely repetitive relative to the trigger of your sampling oscilloscope. If, for each trigger, there is always the same signal, the oscilloscope can adjust the skew using channel deskew. The number of triggers needed to fill the trace doubles relative to an undeskewed acquisition system. More optimal performance can be obtained using multiple modules or modules with channel delay capability.

Random signals are signals that do not necessarily repeat on equivalent trigger events from acquisition to acquisition. The oscilloscope must acquire each waveform sample of both differential branches from exactly the same trigger event. Otherwise, due to the random nature of the signal, one of the samples of the differential pair may have changed value (from an absolute, real-time perspective) and will yield incorrect results of the mathematical differential or common mode waveform.

## Setup Considerations and Procedures

Before starting, there are two setup choices to be made. These are explained in the following sections.

### Reference Plane

This is the location at which you ultimately want both the acquisition signals and TDR steps (if you are using TDR) to be time aligned. (See Figure 4 on page 74.) Common choices for the reference plane include:

- The instrument front panel
- The inputs to a DUT (Device Under Test) attached to cables
- The inputs to a DUT within a fixture

For best results, select the reference plane at the DUT interface. If it is not possible to inject the signal source at the desired reference plane, ensure that the signal paths for each of the differential signals are precisely matched between the DUT and the selected reference plane.

If you are using the 80A05 Clock Recovery Module and routing your differential signals through this module to an acquisition module, you must leave the 80A05 connected during the deskew procedure. This will ensure that any skew introduced by the 80A05 or the connecting cables will be accounted for by the deskew procedure.

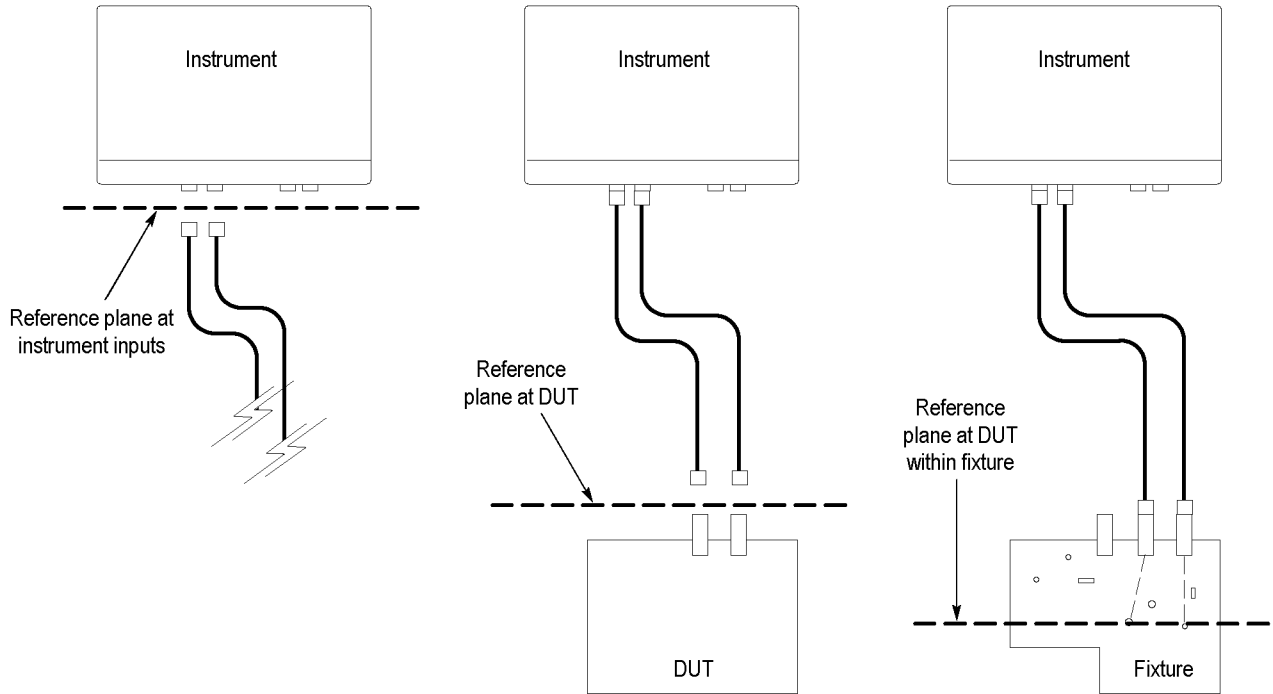

Figure 4: Schematic diagram of reference planes in relation to signal

### Acquisition Deskew Signal Sources

There are three possible signals that may be used as a source to be connected to, or "injected" into, the reference plane.

- A TDR step from an extra (unused) TDR-capable module channel (recommended source)
- A stable, fast-edge, low-repetition rate signal that is synchronous to an external trigger source
- The Internal Clock Output (from the instrument front panel)

The TDR step source is preferred because it provides a fast, stable edge at a low repetition rate that is ideal for deskewing signal paths. The low repetition rate signal should have a repetition rate much lower than the amount of skew that needs to be removed so that the relative skew between signals can be correctly determined.

Following are three procedures to set up your instrument in preparation for performing an Acquisition Deskew. Choose the procedure related to the signal source you are using.

## TDR Step Source

1. Display the TDR setup dialog box by selecting TDR from the Setup menu.
2. Turn on the step by clicking the Preset button for the source channel. This will turn on the step and set other scope parameters (such as trigger source) in preparation for making measurements.

**NOTE.** Use only the rising edge polarity. Autoset in this mode will not find a negative-going edge.

3. Turn off the display of the channel by unchecking the ACQ On box for the source channel. This channel does not need to be displayed.
4. Connect a cable or TDR probe to the source channel to use for injecting the TDR step signal into the reference plane.

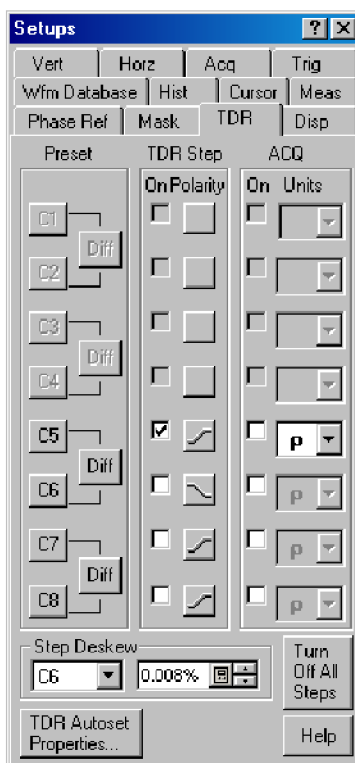

## External Signal

1. Set the trigger source to External Direct or External Prescaler as appropriate for the bandwidth of the trigger signal.
2. Connect the trigger signal to the appropriate mainframe input (TRIGGER DIRECT INPUT or TRIGGER PRESCALE INPUT).
3. Connect a cable or TDR probe to the low-repetition source signal that is synchronous with the trigger signal to use for injecting the signal into the reference plane.

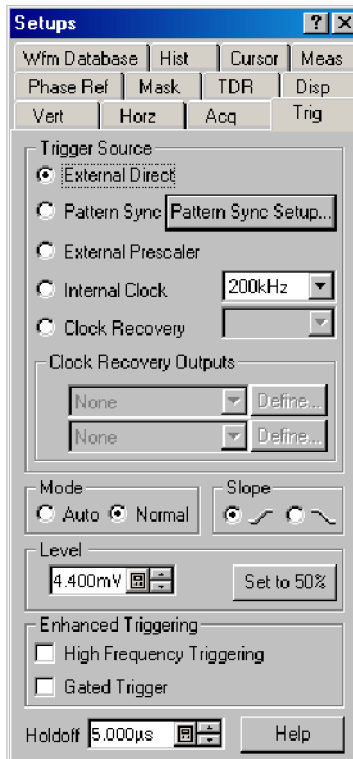

## Internal Clock Output

1. Set the trigger source to Internal Clock.
2. Connect a cable or TDR probe to the INTERNAL CLOCK OUTPUT connector on the front panel of the mainframe to use for injecting the clock signal into the reference plane.

**NOTE.** It might be necessary to use a  $50\ \Omega$  terminated SMA T, a  $50\ \Omega$  terminated power divider, or a 2 – 6 dB attenuator to reduce the Internal Clock Output amplitude to an acceptable amplitude for the module.



For fixture or DUT locations that do not support a cable attachment, the acquisition deskew signal can be injected by a P8018 single-ended TDR probe.

## Acquisition Deskew Procedure

The following procedure outlines a method to deskew a single differential (or common) mode system (one signal pair). The procedure can be extended to additional signal pairs as needed. This method time aligns the acquisition system such that the data is acquired simultaneously at the selected reference plane. The procedure accounts for delay mismatches between the differential signal lines from the reference plane to the acquisition inputs.

In this procedure, we will use Ch5 as the + channel and Ch6 as the – channel.

1. Using the previous discussions on deskew signal types and reference planes, inject your selected source signal at the selected reference plane for the + channel. Turn Ch5 on.
2. From the Utilities menu, select Autoset Properties to display the Autoset Properties dialog box. Choose Edge Mode then click the Autoset button to autoset the signal. Click Close to close the dialog box.
3. Turn on acquisition averaging by clicking on the Acq Mode drop down control and choose Average.
4. Click the Define Math button on the tool bar or press the Math button on the front panel to display the Define Math dialog box.

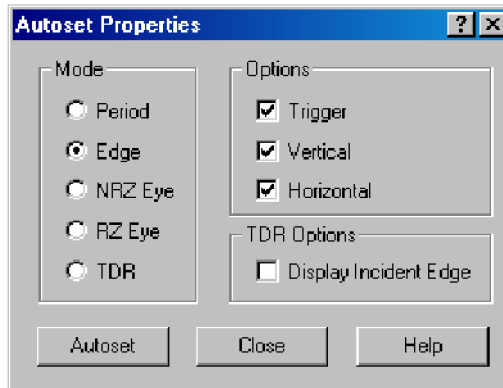

5. Create the following math expression using the buttons in the dialog: Filter(C5). Set the Filter Risetime to a value that is less than half the risetime of the source signal. Check the On box to display the math waveform then close the dialog.

**NOTE.** At this point, you can dismiss the Ch5 display by pressing the CH button on the front panel and then press the 5 button.

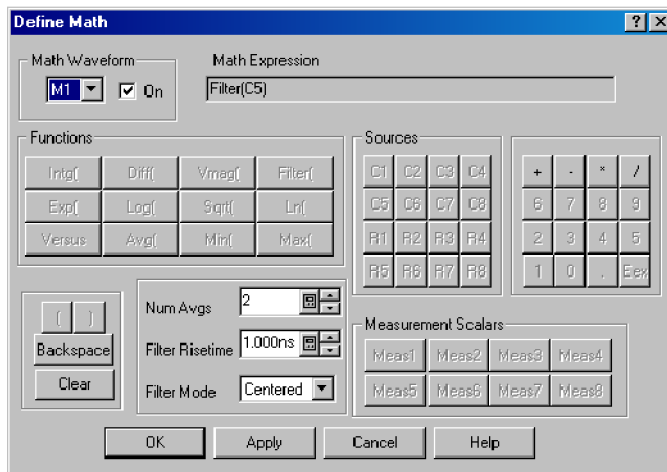
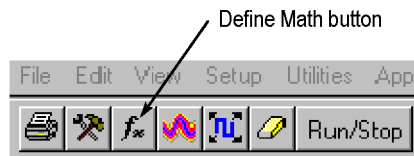



6. Display the Save Waveform(s) dialog box by choosing Save Waveform from the File menu. Save M1 into R1 by clicking the Save button. Click Close to dismiss the dialog box. R1 will automatically be displayed.
7. Connect your selected signal source to the – channel.

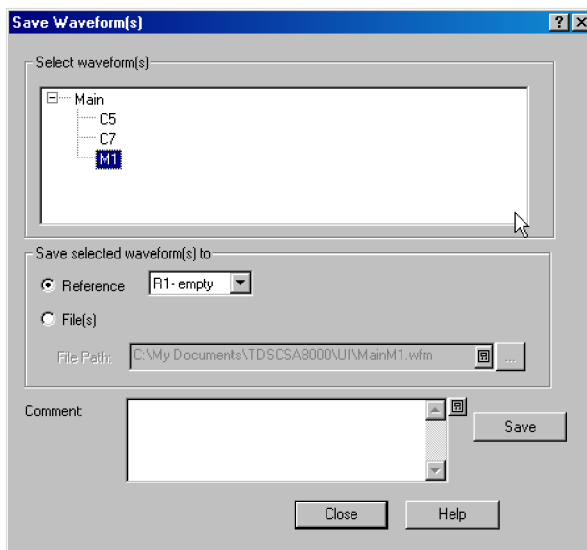

8. Display the Define Math dialog box and modify the math expression to use the – channel: Filter(C6). You can use the Backspace button to edit the expression. Click OK to apply the changes and dismiss the dialog box.

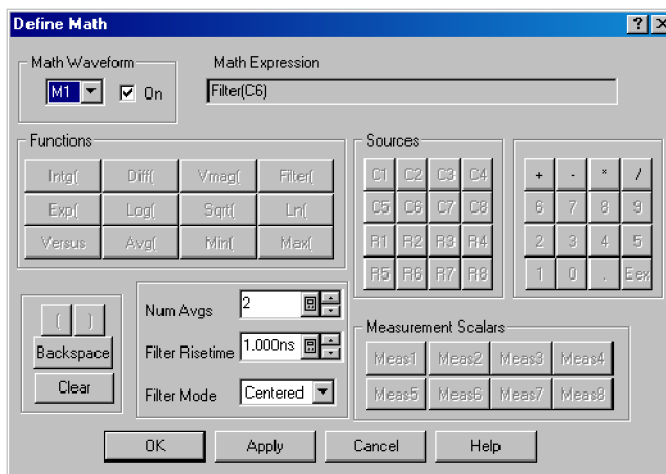

9. From the Utilities menu, select Autoset Properties to display the Autoset Properties dialog box (see step 2 ). Choose Edge Mode then click the Autoset button to autoset the signal. Click Close to close the dialog box.

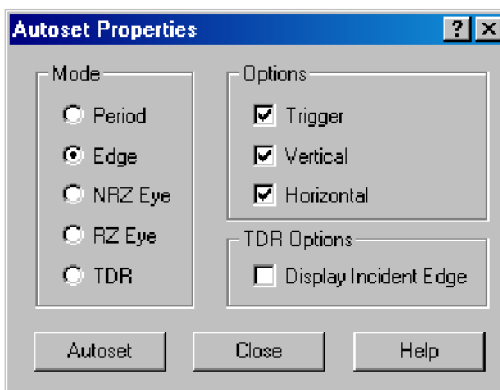

10. Display the Measurement Setup dialog box by choosing Measurement from the Setup menu.
11. Click the Select Meas button and choose the Delay measurement from the Pulse - Timing list. Set Source 1 to R1 and Source 2 to M1.
12. Using the previous discussion on Methods to Adjust Skew, adjust the skew by changing the Delay or Deskew value for C6 or by changing the external phase adjuster until the measurement reads near zero.

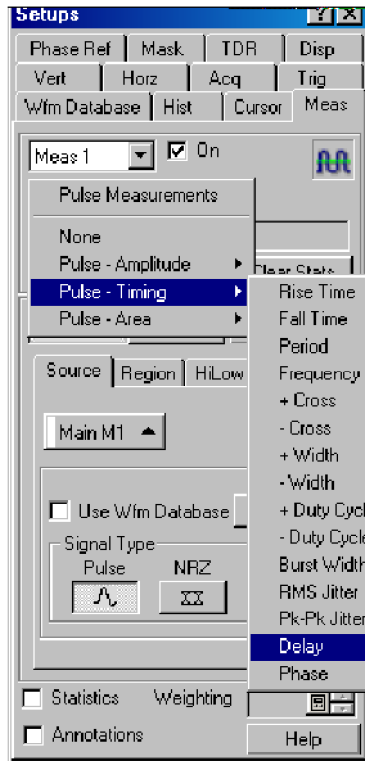

## TDR Step Deskew Procedure

TDR Step Deskew time aligns the TDR steps such that the stimulus steps arrive at the selected reference plane at precisely the same time. This procedure requires that an Acquisition Deskew be performed first so that the acquisition channels are properly aligned. It is important that the same reference plane be used for both the Acquisition Deskew and the TDR Step Deskew procedures to avoid possible misalignment of the signals.

1. Ensure that either an open or a short is present at the reference plane for the TDR channels to be deskewed. For best results, both channels should have the same termination.

**NOTE.** Before proceeding, be sure to set the polarity of the TDR steps to match the step polarities of your application if they are different than the defaults used here (for example, if you are using a common mode measurement).

2. Display the TDR Setup dialog box by choosing TDR from the Setup menu. Click the differential preset button for the channels you will be using. The TDR preset sets the odd channel to a positive step and the even channel to a negative step. In this procedure, we will use Ch5 and Ch6 as the positive and negative channels.
3. Change the units for both channels to V (Volts) then dismiss the dialog box.

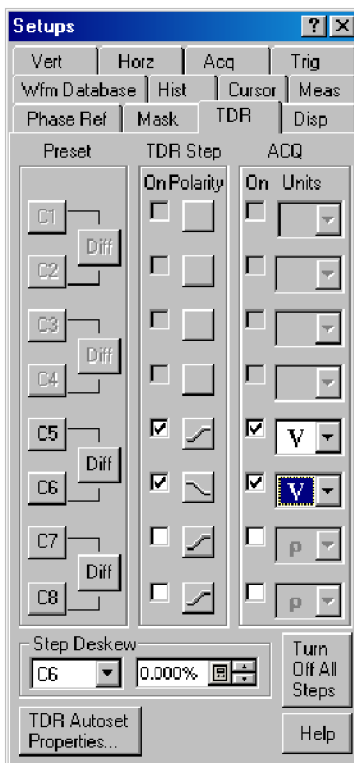

4. Choose Autoset Properties from the Utilities dialog box to display the Autoset Properties dialog box. Choose TDR Mode and clear the Display Incident Edge check box.
5. Perform an autoset by clicking the Autoset button in the dialog box then dismiss the dialog box.
  - a. Given reasonably matched paths to the DUT, both reflected edges should be displayed near the 3rd horizontal graticule. If not, increase the Horizontal Scale until both reflected edges are displayed on the screen.
  - b. Adjust Horizontal Scale (and Position, if necessary), such that the two reflected edges are visible and apart from each other in order to obtain good horizontal resolution. A 10 to 1000 ps/div horizontal scale is a typical target.
6. Click the Define Math button on the tool bar or press the Math button on the front panel to display the Define Math dialog box.
7. Create the following math expression using the buttons in the dialog box: Filter(C5). Set the Filter Risetime to a value that is less than half the risetime of the reflected TDR step. Check the On box to display the math waveform.

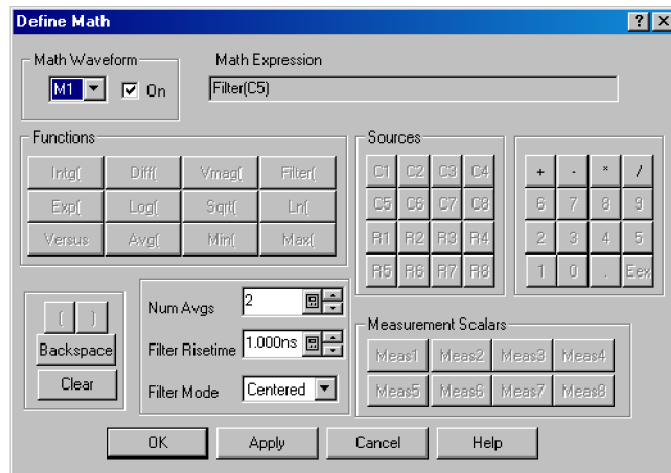
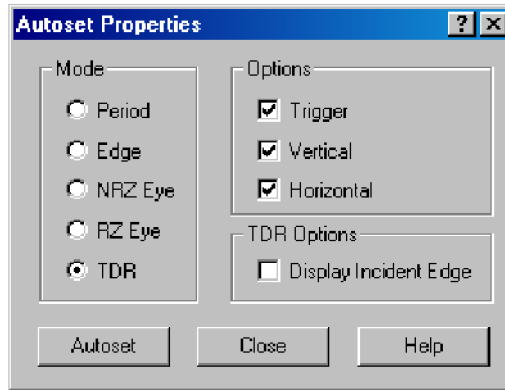

8. Select M2 from the Math Waveform area and create a math expression for the – channel: Filter(C6). Set the Filter Risetime value as before then check the On box to display the math waveform. Dismiss the dialog box.

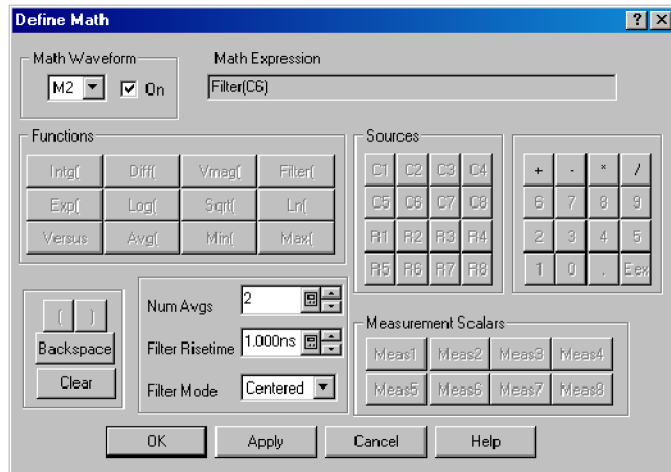

9. Display the Measurement Setup dialog box by choosing Measurement from the Setup menu.
10. Click the Select Meas button and choose the Delay measurement from the Pulse - Timing list. Set Source 1 to M1 and Source 2 to M2.

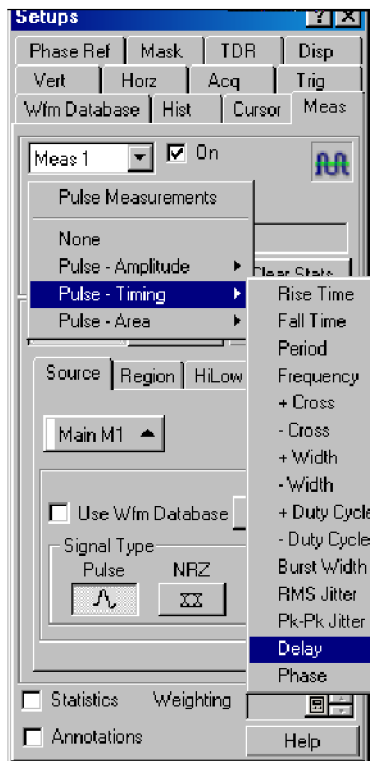

- Click the Region tab in the Setup dialog box and set the Slope to +/- for each source.

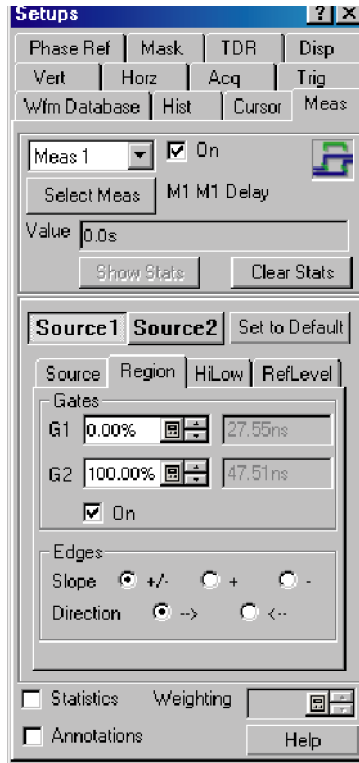

- Display the TDR setup menu by clicking on the TDR tab. Choose which channel you want to adjust from the Step Deskew area. Adjust the Step Deskew value until the measurement reads near zero.

**NOTE.** For future use with the same configuration (i.e., instrument, modules, cables, and/or fixtures), save the setup by selecting *File > Save Setup As...* from the menu bar.

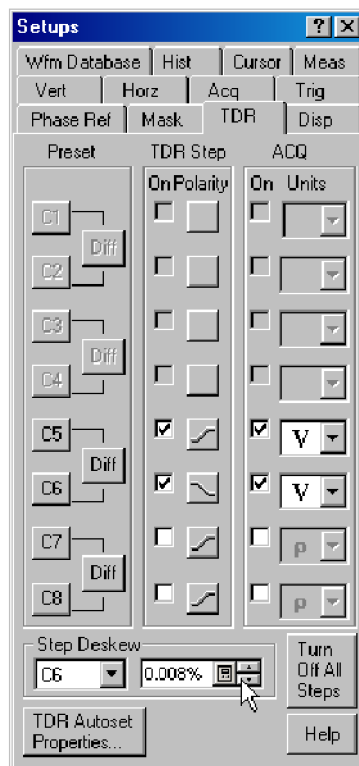

## Cleaning the Instrument

Periodically you may need to clean the exterior of your instrument. To do so, follow the instructions in this section.



---

**WARNING.** Before performing any procedure that follows, power down the instrument and disconnect it from line voltage.

---

### Exterior Cleaning



---

**CAUTION.** To prevent getting moisture inside the instrument during external cleaning, use only enough liquid to dampen the cloth or applicator.

---

Clean the exterior surfaces of the chassis with a dry lint-free cloth or a soft-bristle brush. If any dirt remains, use a cloth or swab dipped in a 75% isopropyl alcohol solution. Use a swab to clean narrow spaces around controls and connectors. Do not use abrasive compounds on any part of the chassis, as they may damage it.



---

**CAUTION.** Avoid the use of chemical cleaning agents, which might damage the plastics used in this instrument. Use a 75% isopropyl alcohol solution as a cleaner and wipe with a clean cloth dampened with deionized water. (Use only deionized water when cleaning the menu buttons or front-panel buttons.) Before using any other type of cleaner, consult your Tektronix Service Center or representative.

---

### Flat Panel Display Cleaning

The instrument display is a soft plastic display and must be treated with care during cleaning.



---

**CAUTION.** Improper cleaning agents or methods can damage the flat panel display. Avoid using abrasive cleaners or commercial glass cleaners to clean the display surface. Avoid spraying liquids directly on the display surface or scrubbing it with excessive force.

---

Clean the flat panel display surface by gently rubbing the display with a clean-room wipe (such as Wypall Medium Duty Wipes, #05701, available from Kimberly-Clark Corporation).

If the display is very dirty, moisten the wipe with distilled water or a 75% isopropyl alcohol solution and gently rub the display surface. Avoid using excess force or you may damage the plastic display surface.

### Optical Connector Cleaning

When using optical modules, the measurement accuracy is increased (or maintained) by keeping the optical connectors clean. It is important to follow the procedures for cleaning optical connectors provided in the manual for your optical module.

## Restoring the Operating System

You can restore the Microsoft Windows operating system in the event that the operating system will not start when powering on the instrument. The restore method is described here, depending on the serial number of your instrument.

<b>Instrument serial number</b>	<b>Operating system restore process</b>
B010100 - B020550	Restore the Windows XP Professional operating system using the restore discs provided with the instrument.
B020551 - B029999	Restore the Windows XP Professional operating system from the instrument hard disk drive. This is the preferred method for these instruments. Restore the Windows XP Professional operating system using a set of user-created restore discs.
B030000 and above	Restore the Windows XP Embedded operating system using the restore discs provided with the instrument.



**CAUTION.** *The restore process reformats the hard drive and reinstalls the operating system. All saved data will be lost. If possible, save important files to external media before you perform an operating system restore.*

---



---

## Restoring the Operating System with Restore Discs

---

**NOTE.** This procedure requires that the CD/DVD drive is set as the first boot device (this is the default setting).

---

---

**NOTE.** You can only use restore discs on the instrument with which they were created. This includes restore discs shipped with the instrument or restore discs created by the user.

---

1. Insert restore CD disc 1 in the instrument CD/DVD drive.
2. Restart the instrument. The restore software opens automatically if the CD/DVD drive is the first bootable device. If the CD/DVD drive is not the first bootable device you will need to enable it as the first bootable device before performing a restore from the CD-ROMs.
3. Click **Restore**.
4. In the Confirmation dialog box, click **Yes** to restore the operating system and instrument application, or **No** to exit the restore process.
5. When prompted, remove the current restore disc and insert the next restore disc. Continue until the restore process is complete.
6. When the restore process is completed, remove the last restore disc and restart the instrument. The instrument will open into the operating system, settings, and appearance as shipped from the factory.
7. Proceed to restoring the product software and any additional applications. Follow each application's installation instructions.

## Restoring the Operating System from the Instrument Hard Disk Drive (SN B020551 through B029999)

These instruments contain an operating system restore file on a separate partition of the hard disk drive.

---

**NOTE.** This restore method reinstalls the operating system but does not restore the backup directory on the hard disk drive.

---

If you are using this restore method, when complete, be sure to create a set of operating system restore CD-ROMs for future restores. (See page 88, *Create Restore CD-ROMs (Serial Numbers B020551 to B029999)*.)

1. Restart the instrument. During the boot-up process you will see the following message at the top of the screen:  
Starting Acronis Loader... press F5 for Acronis Startup Recovery Manager
2. Repeatedly press the F5 key until the Acronis True Image Tool opens. There is a three-second time period from when the message appears until the instrument proceeds with the normal instrument startup. If the instrument does not open the Acronis application, power off the instrument, then power on the instrument and try again.
3. Click **Restore**.
4. In the Confirmation dialog box, click **Yes** to restore the instrument operating system, or **No** to exit the restore process. The restore process takes approximately 30 minutes; the actual time depends on the instrument configuration.

## Create Restore CD-ROMs (Serial Numbers B020551 to B029999)

Instruments with serial numbers B020551 and above did not ship with operating system restore CD-ROMs. Use the following procedure to create a set of CD-ROMs that enable you to restore the operating system if the need arises.

---

**NOTE.** Restoring from a set of CD-ROMs is necessary in the event of a complete hard disk failure. The typical restore process is performed from the instrument hard disk.

---

**Prerequisites.** Blank CD-R discs (about 5; the exact number depends on the number of backup files) to create a set of bootable CD-Roms.

1. Open the Windows **My Computer**.
2. Navigate to **C:\backup**. This folder contains a set of disk image files (e.g. backup1.iso, backup2.iso, ...).
3. Copy the disk image files (\*.iso) (for backup purposes) using one of these methods:
  - Copy the image files to blank CD-R discs using the Windows built-in utility to copy files to the DVD/CD-RW Drive.
  - Copy the image files to a network location, a separate hard disk, or a USB flash drive.

To create a set of restore discs:

4. Once the disk image files have been copied, you can create (burn) a set of bootable CD-ROMs using a 3rd party utility. Bootable CD-ROMs are required to restore the operating system if the hard disk has failed.

---

**NOTE.** When creating restore discs, label each disc appropriately, numbering the discs in sequence with its respective backup file name.

---

5. Store the copied disk image files and/or restore discs as defined by your company policy.

---

**NOTE.** Operating system restore discs can only be used on the instrument from which they were created.

---

# Index

## A

- Accessories, 3
- Acquisition
  - set Stop mode & action, 34
- Acquisition modes
  - how to set, 34
- Annotations, 46
  - show, 44
- Auto
  - trigger mode, 37
- Automatic measurements
  - how to localize (gates), 46
- Autoset, 32

## C

- Calibration, 25
- Channel delay, 72
- Channel deskew, 72
- Characterize
  - phase correction, 61
- Cleaning
  - instrument exterior, 85
  - instrument, how to, 85
- Cleaning and inspection
  - flat panel display, 85
- Cleaning optical connectors, 85
- Clock recovery
  - trigger source, 38
- Communication
  - signal, 53
  - signal:mask testing, 54
- Compensation, 25
  - how to perform, 25
- Compensation indicator, 17
- Compliance information, v
  - EMC, v
  - Safety, vii
- Computer I/O panel, 17
- Connectors
  - external direct, 37, 38
  - external prescale, 38
  - trigger, 38
- Control panel, 13
- Control panel map, 14
- Controls bar, 17
- Create restore CD-ROM, 88
- Cursor measurements, 48

## Cursors

- H Bars, 48
- V Bars, 48

## D

- Dark-level compensation
  - how to perform, 27
- Default setup, 32
- Deskew, 72
  - acquisition deskew, 78
  - reference plane, 73
  - signal sources, 74
  - TDR step, 81
- Diagnostics, 23
- Dimensions, 4
- Display
  - map - main & mag views, 20
  - map - main view, 19
- Display map, 19
- Display style
  - normal, 35
  - show vectors, 35
- Document results, 63
- Documentation, x
- Dual monitor, 8

## E

- Enable histogram, 61
- Environmental
  - specifications, 4
- Environmental considerations, ix
- Export
  - waveform, 63
- Extended desktop, 8

## F

- Features, 1
- Flat panel display
  - cleaning, 85
- Frame
  - trigger, 38
- Frame Scan, 57
- Front panel
  - connectors, 13

## G

- Gated trigger, 39
- Graticule
  - color, 36
  - style, 36

## H

- H Bars cursor, 48
- High frequency triggering, 39
- Histogram
  - enable, 61
  - statistics, 62
- Histograms, 61
- Holdoff
  - triggering, 39
- Horizontal
  - set up procedure, 30

## I

- Incoming inspection, 23
- Input connectors
  - specifications, 4
- Input frequency, 60
- Inspection and cleaning
  - flat panel display, 85
- Installation, 3
- Installing modules, 6
- Instrument
  - cleaning, 85
  - restore, 86, 88
- Interface map, 17

## K

- Key features, 1
- Knob
  - trigger main level, 37

## L

- Language
  - changing, 10
- Level
  - trigger, 37
- Linear interpolation, 35

**M**

- Map
  - waveform display, 19
- Mask testing, 54
  - autoset to a mask, 55
  - stopping acquisition based on, 55
- Math
  - editor, 50
  - waveform, 50
- Measurement accuracy
  - optimizing, 25
- Measurement bar, 17
- Measurement readouts, 17
- Measurements, 43
  - cursor, 48
  - how to localize (gates), 46
  - turning off, 47
- Mechanical
  - specifications, 4
- Menu bar, 17
- Mode
  - trigger, 37

**N**

- Normal
  - trigger mode, 37
- Normal display style, 35

**O**

- Online help, 20
  - displaying control descriptions, 20
  - displaying overviews, 22
  - using the finder, 22
- Operating specifications, 4
- Operating system
  - restore, 86, 88

**P**

- Pattern Sync
  - trigger source, 38
- Phase correction, 60, 61
  - input frequency, 60
- Phase reference, 60
- Power supply
  - specifications, 4
- Print, 63

**Procedure**

- to compensate the instrument and modules, 25
- to localize a measurement, 46
- to perform acquisition
  - deskew, 78
- to perform dark-level and user wavelength gain compensations, 27
- to perform TDR step
  - deskew, 81
- to set acquisition modes, 34
- to set up the signal input, 30

**R**

- Readout bar, 17
- Readouts display, 17
- Rear panel
  - connectors, 16, 17
- Related documentation, x
- Restore
  - instrument, how to, 86, 88

**S**

- Safety Summary, iii
- Save
  - setup, 63
  - waveform, 63
- Serial mask testing, 54
- Setup
  - save, 63
- Setup boxes, 33
- Show vectors, 35
- Signal
  - communication, 53
- Sin(x)/x interpolation, 35
- Single sequence, 34
- Skew, 72
  - adjusting, 72
- Slope
  - trigger, 37
- Sources
  - trigger, 37
- Specifications
  - environmental, 4
  - input connectors, 4
  - mechanical, 4
  - operating, 4
  - power supply, 4
- Spread Spectrum Clocking, 60

**SSC, 60**

- Start an acquisition, 34
- Statistics
  - histogram, 62
- Status bar, 17
- Stop an acquisition, 34

**T**

- TDR, 58
- Temperature compensation, 25
- Tool bar, 17
- Trigger
  - clock recovery source, 38
  - concepts, 37
  - connector, 38
  - edge, 37
  - event, 37
  - external direct connector, 37, 38
  - external prescale connector, 38
  - frame, 38
  - level, 37
  - main level knob, 37
  - modes, 37
  - pattern sync, 38
  - slope, 37
  - sources, 37
  - type, 37
- Trigger inputs
  - usage limitations, 38
- Trigger source
  - usage limitations, 38
- Triggering
  - gated, 39
  - high frequency, 39
  - holdoff, 39

**U**

- User interface, 17
- User wavelength compensation
  - how to perform, 27

**V**

- V Bars cursor, 48
- Variable Persistence, 35
- Vertical
  - set up procedure, 30
- View
  - main & mag, 20

**W**

## Waveform

display style, 35

export, 63

save, 63

## Waveform bar, 17

## Waveform cursors, 48, 49